

X4 Series

GASTECH
AUSTRALIA



USER AND MAINTENANCE MANUAL SAA VERSION

Portable Multi-Gas Detector

TABLE OF CONTENTS

Important Notice	4
Warnings and Cautions 	4
Contacting Honeywell Analytics	5
1. Introduction	7
1-1. Product Overview	7
1-2. Basic Button Operation	8
1-3. LCD Display	8
1-4. Standard Accessories	9
2. Turning the Detector On and Off	9
2-1. Turning the Detector On	9
2-1-1. Displaying the Firmware Version	9
2-1-2. Clearing the STEL and TWA Values	10
2-1-3. Checking the Memory Card	10
2-1-4. Power-Up Self-Test	11
2-1-5. Checking the Calibration Due Date	11
2-2. Turning the Detector Off	11
3. Operation	12
3-1. Performing a Self-Test	12
3-2. Measuring Mode	13
3-2-1. Flipping the Display	14
3-3. Gas Alarms	14
3-3-1. Gas Alarms for the MiniMAX4 series	15
3-3-2. Gas Alarms for the ImpulseX4 series	15
3-4. Gas Exposure Status Review	17
3-5. Confidence Flash/Beep	18
3-6. Low Battery	18
3-7. Data Logging	18
4. Calibration	19
4-1. Calibration Prompt	19
4-2. Zero Calibration (Span Calibration for Oxygen)	20
4-3. Span Calibration (for Flammable and Toxic Sensors Only)	20
4-3-1. Pass Code Input	21
4-3-2. Span Gas Information	22
4-3-3. Span Gas Setting	22
4-3-4. Gas Search and Countdown	22
4-3-5. Span Calibration Result	23

5. Set-Up Mode	24
5-1. Entering the Set-Up Mode	25
5-2. Changing the Detector Set-Up	25
5-3. Exiting the Set-Up Mode	26
6. Maintenance	26
6-1. Replacing the Batteries	26
6-2. Installing or Removing the Memory Card	27
6-3. Cleaning	27
6-4. Replacing the Expired Sensor	28
7. Optional Accessories	28
8. System Configuration Options	29
8-1. System Configurations for the MiniMAX4 series	29
8-2. System Configurations for the ImpulseX4 series	29
Appendix A	30
A-1. Calibration Mode Menu Structure 1/2	30
A-2. Calibration Mode Menu Structure 2/2	31
A-3. Set-up Mode Menu Structure 1/4	32
A-4. Set-up Mode Menu Structure 2/4	33
A-5. Set-up Mode Menu Structure 3/4	34
A-6. Set-up Mode Menu Structure 4/4	35
Appendix B	36
B-1. Sensor Cross-Sensitivity	36
B-1-1. H ₂ S and CO SureCell Cross-Sensitivity	36
B-1-2. O ₂ Cross-Sensitivity	36
B-1-3. Flammable Cross-Sensitivity	37
B-2. Flammable Lower Explosive Limit	37
Appendix C	38
C-1. Warranty	38
C-2. Accuracy Statement	38
Appendix D	41
D-1. Specifications	41
D-1-1. Specifications for the MiniMAX4 series	41
D-1-2. Specifications for the ImpulseX4 series	42

IMPORTANT NOTICE

System configurations of the detector are available with 4, 3, 2, and 1 gas sensor(s) installed in order to provide specific protection for most major industrial applications and compliance requirements. Though this operating manual is provided for the detector with 4 gas sensors installed, the information in the manual also applies to other system configurations of the detector with 3, 2, and 1 gas sensor(s) installed as well (See Section 8 System Configurations Options).

To ensure proper functioning of this product, do not use it until you read and completely understand this operating manual. It contains operating and maintenance procedures to ensure proper detector function. For your safety, it is required to calibrate the detector periodically (See Section 4 Calibration).

Honeywell Analytics can take no responsibility for use of its equipment if it is not used in accordance with the instructions stated in the relevant manual. If further details are required but not provided in this manual, contact Honeywell Analytics or their agent.

Honeywell Analytics shall not be liable for any incidental or consequential damages in connection with any modifications, errors or omissions in this manual.

While every effort has been made to ensure accuracy in this publication, no responsibility can be accepted for errors or omissions. This publication is not intended to form the basis of a contract, and the company reserves the right to amend the design and specifications of the detectors without notice. Note too that data may change as well as legislation, and you are advised to obtain copies of the most recently issued regulations, standards and guidelines.

WARNINGS AND CAUTIONS

- Substitution of any components may impair intrinsic safety.
- Use only approved memory cards, part # 2566-0435, which are available from Honeywell Analytics. Use of any other manufacturer or type will violate intrinsic safety requirements.
- Activation of the detector after the date on the packaging means less usable life and shorter warranty period.
- Use only approved 'AA' Alkaline Batteries, Energizer® E91 or EN91: Use of any other manufacturer or type will violate intrinsic safety requirements.
- Use only two new batteries of the same type, when replacing the batteries.
- Replace batteries as soon as the detector emits a low battery alarm.
- Battery life will be reduced at low temperatures.
- Replace batteries only in an area known to be NON-HAZARDOUS.
- Instrument contains no user serviceable parts. Contact Honeywell Analytics for any servicing requirements.
- Perform a Self-Test prior to each day's use (See Section 3-1 Performing a Self-Test).
- Periodically test the sensors' response to gas by exposing the monitor to a target gas concentration that exceeds the alarm set points. Verify proper operation of audible, visual and vibrating alarms during this test.
- Use only factory supplied calibration gas for calibration. Accurate calibration can be achieved only if specific concentrations of the correct gases are used.

- Calibration should be carried out in a well-ventilated area to avoid contaminants.
- Calibration cannot be carried out when the detector emits a low battery alarm.
- Do not use the detector in oxygen-enriched atmospheres.
- The flammable sensor's sensitivity can be adversely affected by exposure to certain substances called "poisons". Sulfur compounds, phosphorus containing compounds, halogens, silicone or lead containing compounds are examples of such poisons. Every effort should be made to avoid exposure to these substances. When the detector is exposed to such substances, a gas test should be performed on the flammable sensor to verify its accuracy and a calibration performed if necessary.
- Extended exposure of the detector to certain high concentrations of flammable gases and air may stress the flammable detector element, which can seriously affect its performance. If an alarm occurs due to high concentration of flammable gases, recalibration should be performed, or if needed, the sensor replaced.
- Do not use solvents, soap, polishes or any product containing silicon compounds to clean the detector as these can cause damage to the sensors.
- Do not expose the detector to electrical shock and/or severe mechanical shock. When the detector is exposed to such shocks, a check should be performed on the sensors to verify its accuracy and a calibration performed if necessary.
- Disabling one or more installed sensors configures the detector to a 1, 2, or 3-gas unit. No protection is provided for the gas targeted by the disabled sensor(s).
- Do not install or remove the memory card in the detector or attempt to read, download or write to the memory card using a memory card reader and/or computer in potentially hazardous atmospheres.
- Do not remove the batteries from the detector while the power is on. This can cause fatal damage to the optional memory card if installed.
- No gas will be detected while in the set-up mode or the gas exposure status review mode.
- The desktop USB memory card reader and data logging kit are not certified intrinsically safe and must not be used in potentially hazardous atmospheres.

CONTACTING HONEYWELL ANALYTICS

Zenter Americas (for MiniMAX4 series)

Tel: +1 954 514 2700

Toll free: +1 800 538 0363

Fax: +1 954 514 2784

E-mail: sales@zelana.com

Zenter Europe (for ImpulseX4 series)

Tel: +41 (0) 1 943 4300

Fax: +41 (0) 1 943 4398

E-mail: sales@zelana.co.uk

Or visit our website at
www.honeywellanalytics.com

ADDITIONAL WARNINGS AND CAUTIONS FOR OTHER CERTIFICATION BODIES

WARNING: SUBSTITUTION OF ANY COMPONENTS MAY IMPAIR INTRINSIC SAFETY.

CAUTION: FOR SAFETY REASONS THIS EQUIPMENT MUST BE OPERATED AND SERVICED BY QUALIFIED PERSONNEL ONLY. READ AND UNDERSTAND INSTRUCTION MANUAL COMPLETELY BEFORE OPERATING OR SERVICING.

CAUTION: HIGH OFF-SCALE READING MAY INDICATE EXPLOSIVE CONCENTRATION.

CAUTION: BEFORE EACH DAY'S USAGE SENSITIVITY MUST BE TESTED ON A KNOWN CONCENTRATION OF METHANE EQUIVALENT TO 25-50%LEL. ACCURACY MUST BE WITHIN +/-20% OF ACTUAL CONCENTRATION. ACCURACY MAY BE CORRECTED BY PERFORMING PROPER CALIBRATION ON THE DETECTOR.

WARNING: UNDER PROPER CALIBRATION PROCEDURES, REPETITIVE CALIBRATION FAILURES COULD INDICATE THAT THE SENSOR IS EITHER APPROACHING ITS END OF LIFE, OR IT HAS BEEN SERIOUSLY CONTAMINATED, OR BOTH.

WARNING: THE DETECTOR MUST NOT BE REMOVED FROM ITS RUBBER BOOT DURING TRANSPORTATION OR USE, AND IF THE RUBBER BOOT IS REMOVED FOR SERVICING OR ANY OTHER REASON, IT MUST BE REPLACED BEFORE THE INSTRUMENT IS PLACED BACK IN SERVICE.

1. INTRODUCTION

The X4 series is an easy to use personal gas detector, designed for monitoring the atmosphere for potentially hazardous levels of flammables, oxygen, carbon monoxide, and hydrogen sulfide. It uses a front-mounted LCD display to show readings of the gases being measured and other useful information. A loud audible alarm and bright visual alarm are used to warn users when the concentrations of measured gases exceed the alarm set points. It has built-in cell decay compensation, thermal shock protection, and Reflex™, a patented cell check technique, for maximum reliability.

1-1. PRODUCT OVERVIEW

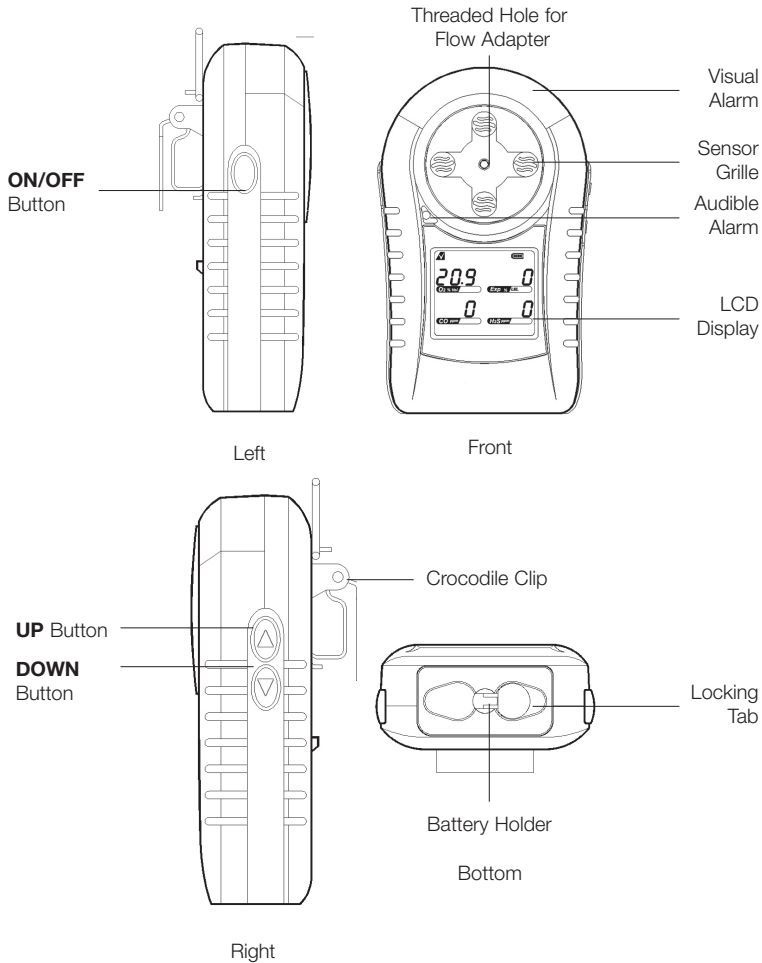

1-2. BASIC BUTTON OPERATION

ON/OFF button

- Turn on the detector
- Turn off the detector
- Self-Test
- ZERO calibration
- SPAN calibration
- Accept a user set-up change

UP button

- Scroll through status or menu options
- Increase value
- Activate/deactivate flipped display
- Activate backlight

DOWN button

- Scroll through status or menu options
- Decrease value
- Activate backlight

1-3. LCD DISPLAY

1. Test Pass Icon
2. Test Fail Icon
3. High Peak Icon
4. Low Peak Icon (for O₂ only)
5. Alarm Icon
6. Data Logging Icon
7. Battery Icon
8. Pass Code Protection Icon
9. %Vol Unit Icon
10. %LEL Unit Icon
11. STEL Icon
12. TWA Icon
13. Alarm Level 1 Icon ▲
Alarm Level 2 Icon ▲
(for flammable and toxic)
14. Zero Calibration Icon 0
Span Calibration Icon 1
15. Gas Label Icon
16. O₂ Deficiency Alarm Icon
17. O₂ Excess Alarm Icon

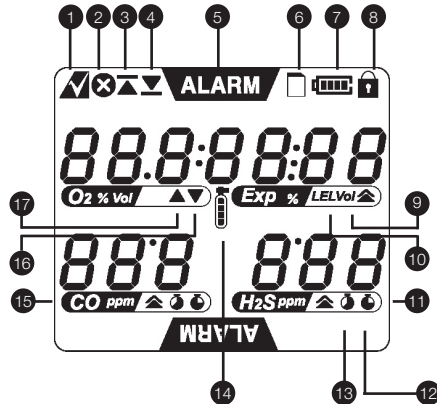

The LCD display has a backlight that will operate automatically whenever an alarm occurs, and also whenever any button is pressed. To turn on the backlight while staying in the measuring mode in a low light area, press the **UP** or **DOWN** button once.

1-4. STANDARD ACCESSORIES

The items listed below are included with the X4 series. For damaged or missing parts, contact Honeywell Analytics or their agent.

Part No.	Description	Qty
2566-0424	Calibration Certificate	1
2566-0422	Quick Start Guide	1
2566-0433	Alkaline Batteries (1.5V AA), Energizer® E91 or EN91	2
2566-0426N	Flow Adaptor (Neotronics)	1
2566-0426L	Flow Adaptor (Lumidor)	1
2566-0480	Protective Rubber Boot (Neotronics)	1
2566-0445	Protective Rubber Boot (Lumidor)	1
2566-0443	Tubing (45 cm/18")	1
2566K0130	Crocodile Clip Kit	1
1998-0637	Manual	1

2. TURNING THE DETECTOR ON AND OFF

Before turning the detector on for the first time, you will need to install two "AA" alkaline (Energizer® E91 or EN91) batteries (See Section 6-1 Replacing the Batteries).

If you plan on logging data and have a memory card, now is also a good time to install the card (See Section 6-2 Installing or Removing the Memory Card).

2-1. TURNING THE DETECTOR ON

Press and hold the **ON/OFF** button for 2 seconds and the detector will turn on.

2-1-1. DISPLAYING THE FIRMWARE VERSION

The detector will display the version of the firmware.

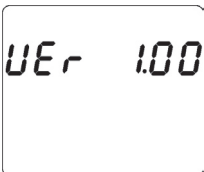

2-1-2. CLEARING THE STEL AND TWA VALUES

When the non-zero STEL and/or TWA values are carried over from the previous measurement, a "Delete no" prompt will be displayed with the gas labels and the STEL and TWA icons. (When the STEL and TWA values are zero, the "Delete no" prompt will not be displayed.)

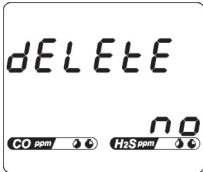

Press the **UP** or **DOWN** buttons to scroll to "no" or "YES" and press the **ON/OFF** button to select.

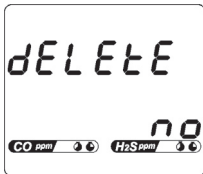

or

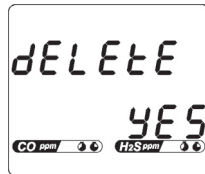

When "no" is selected, the recorded STEL and TWA values will be used as initial STEL and TWA values for the current session. When "YES" is selected, the STEL and TWA values will be cleared.

2-1-3. CHECKING THE MEMORY CARD

The detector will check the memory card in the memory card slot. When a properly formatted FAT16 memory card with a data full condition is detected, a "Data Fu" message will be displayed followed by a "Delete no" prompt. (When a properly formatted FAT16 memory card is not full of data, the "Data Fu" message and the "Delete no" prompt will not be displayed).

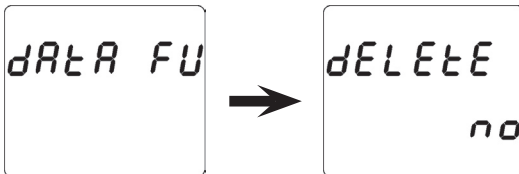



Press the **UP** or **DOWN** buttons to scroll to "no" or "YES" and press the **ON/OFF** button to select.

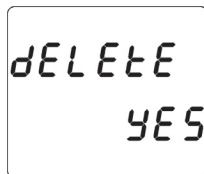

or





When "no" is selected, the detector keeps the current data file and the Data Logging icon  will not be displayed in the measuring mode which indicates that no data is being logged. When "Yes" is selected, the detector deletes the current data file and creates a new file for data logging. The Data Logging icon  will be displayed in the measuring mode which indicates that data is being logged.

The detector does not support either FAT32 or NTFS format for the memory card. When a memory card with non-FAT16 format is detected, a "Card Er" message will be displayed with a single beep. (When a properly formatted FAT16 memory card is detected, a "Card Er" message will not be displayed.)



The Data Logging icon  will not be displayed in the measuring mode which indicates that no data is being logged.

2-1-4. POWER-UP SELF-TEST

The detector will beep and perform a power-up Self-Test. If the detector passes the Self-Test, the Test Pass icon  is displayed. If the Test Fail icon  is displayed and the Test Pass icon  blinks with 1 beep and 1 flash every 5 seconds, then the detector has failed the Self-Test (See Section 3-1 Performing a Self-Test).

2-1-5. CHECKING THE CALIBRATION DUE DATE

The detector checks the calibration due date stored in the detector after the Power-Up Self-Test. When the number of days remaining until calibration is due reaches zero, a "CAL dUE dAY 0" message will be displayed to remind the user that a calibration needs to be performed.

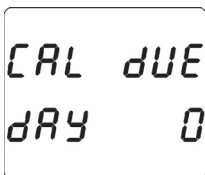

To perform the calibration, see Section 4 Calibration.

2-2. TURNING THE DETECTOR OFF

To turn off the detector, press and hold the **ON/OFF** button while in the measuring mode. A countdown will be displayed for 5 seconds, and then the detector will beep and turn off.

3. OPERATION

3-1. PERFORMING A SELF-TEST

When the **ON/OFF** button is pressed, the detector checks the sensor, circuit, batteries, and audible, visual, and vibrating alarms.

The detector will do the following:

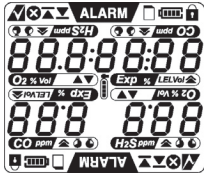

- Turn on all the display elements
- Test the audible, visual, and vibrating alarms
- Check the battery, electronic circuit and sensors

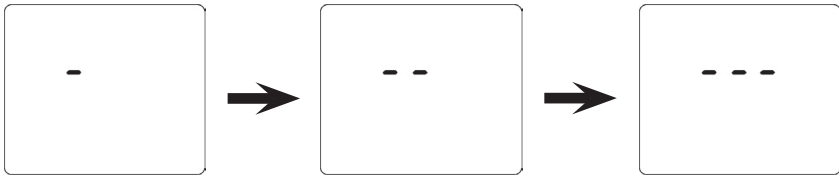

- Display the level 1 (flammable and toxic low, O₂ excess) and level 2 (flammable and toxic high, O₂ deficiency) alarm set points
- Display the STEL and TWA alarm set points (for CO & H₂S only)

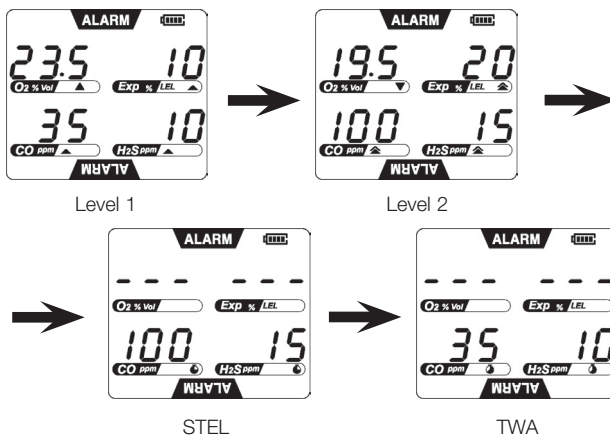

**Examples shown for default settings of each gas for the MiniMAX4 series.*

- Display the result of the Self-Test as follows:

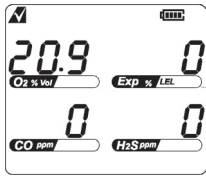

Test Pass

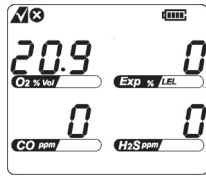

Test Fail

Self-Test Result	Display	Audible Alarm	Visual Alarm
Pass		None	None
Fail		1 beep every 5 seconds	1 flash every 5 seconds

Additionally, the detector will periodically check its batteries, electronic circuit and sensors.

If it passes, the Test Pass icon will be displayed. If it fails, the Test Fail icon will be displayed and the Test Pass icon will blink with 1 beep and 1 flash every 5 seconds.

Note: If the Self-Test has failed, repeat the Self-Test. If a second failure occurs, contact Honeywell Analytics or their agent

3-2. MEASURING MODE

The detector may be used as either a “diffusion” or “sample-draw” type monitoring device. In normal operation, the detector is worn on the belt or held by hand. Once turned on, the detector monitors continuously. The atmosphere being measured reaches the sensor by diffusion through the vents of the grille cover. Normal air movements are enough to carry the sample to the sensors, which react to the concentrations of the gases being measured. This type of “diffusion” operation monitors only the atmosphere that immediately surrounds the detector. It is possible to use the detector to sample locations that are remote from the detector by using a flow adaptor and an optional hand aspirator. When using the flow adaptor, ensure that the sample flow direction matches the arrow mark.

The gas types and concentration values for each sensor are displayed. If fewer than four sensors are installed, the unused sensor position(s) will be blank.

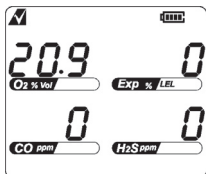

Normal Display

3-2-1. FLIPPING THE DISPLAY

The LCD display can be flipped upside down by pressing and holding the **UP** button for 2 seconds. This allows easy reading when the detector is clipped to a waist belt or chest pocket.

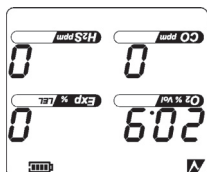

Flipped Display

Note: Flipped display is not available in calibration and set-up modes.

3-3. GAS ALARMS

The detector has two levels of instantaneous gas alarms, of which the level 2 (flammable and toxic high, O₂ deficiency) alarm is more urgent than the level 1 (flammable and toxic low, O₂ excess) alarm for flammable and toxic. The O₂ excess and deficiency alarms are equally important. It also has a 15-minute STEL alarm and an 8-hour TWA alarm for the carbon monoxide and hydrogen sulfide sensors.

Note: STEL (Short Term Exposure Limit) and TWA (Time-Weighted Average) comply with relevant agency standards.

Note: TWA is an 8-hour time-weighted average, so if the work shift exceeds 8 hours, the readings will still be logged but averaged over the 8-hour period.

The user can set up the level 1 alarm point, level 2 alarm point, STEL alarm point, TWA alarm point and alarm latch mode in the set-up mode. (See Section 5 Set-Up Mode).

3-3-1. GAS ALARMS FOR THE MINIMAX4 SERIES

The MiniMAX4 series is supplied with the following alarm increments, alarm ranges, and default alarm set points:

Gas Type	All Alarms Increment	Level 1 (Flammable and Toxic Low, O ₂ Excess) Alarm		Level 2 (Flammable and Toxic High, O ₂ Deficiency) Alarm		STEL Alarm		TWA Alarm	
		Range	Default	Range	Default	Range	Default	Range	Default
Oxygen (O ₂)	0.1% Vol	21.5 ~ 30.0% Vol	23.5% Vol	1.0 ~ 20.5% Vol	19.5% Vol	N/A	N/A	N/A	N/A
Flammable (Exp)	1% LEL or 0.01% Vol	2~ 60% LEL or 0.10~ 3.00% Vol	10% LEL or 0.50% Vol	2~ 60% LEL or 0.10~ 3.00% Vol	20% LEL or 1.00% Vol	N/A	N/A	N/A	N/A
Carbon Monoxide (CO)	1 ppm	5 ~ 999 ppm	35 ppm	5 ~ 999 ppm	100 ppm	5 ~ 999 ppm	100 ppm	5 ~ 999 ppm	35 ppm
Hydrogen Sulfide (H ₂ S)	1 ppm	3 ~ 250 ppm	10 ppm	3 ~ 250 ppm	15 ppm	3 ~ 250 ppm	15 ppm	3 ~ 250 ppm	10 ppm

3-3-2. GAS ALARMS FOR THE IMPULSEX4 SERIES

The ImpulseX4 series is supplied with the following alarm increments, alarm ranges, and default alarm set points:

Gas Type	All Alarms Increment	Level 1 (Flammable and Toxic Low, O ₂ Excess) Alarm		Level 2 (Flammable and Toxic High, O ₂ Deficiency) Alarm		STEL Alarm		TWA Alarm	
		Range	Default	Range	Default	Range	Default	Range	Default
Oxygen (O ₂)	0.1% Vol	21.5 ~ 30.0% Vol	23% Vol	1.0 ~ 20.5% Vol	19% Vol	N/A	N/A	N/A	N/A
Flammable (Exp)	1% LEL or 0.01% Vol	2~ 60% LEL or 0.10~ 2.64% Vol	10% LEL or 0.44% Vol	2~ 60% LEL or 0.10~ 2.64% Vol	20% LEL or 0.88% Vol	N/A	N/A	N/A	N/A
Carbon Monoxide (CO)	1 ppm	5 ~ 999 ppm	35 ppm	5 ~ 999 ppm	400 ppm	5 ~ 999 ppm	200 ppm	5 ~ 999 ppm	30 ppm
Hydrogen Sulfide (H ₂ S)	1 ppm	3 ~ 250 ppm	10 ppm	3 ~ 250 ppm	40 ppm	3 ~ 250 ppm	10 ppm	3 ~ 250 ppm	5 ppm

Note: For flammable, carbon monoxide, and hydrogen sulfide, level 1 alarm can only be set to less than or equal to the level 2 alarm. When level 1 and level 2 alarms are set to the same value, the level 2 alarm action overrides the level 1 alarm.

Note: The maximum value of the level 2 alarm in %Vol for flammable gas varies depending on the gas. (See Appendix B-2 Flammable Lower Explosive Limit.)

If an alarm occurs, the **ALARM** icons blink and relevant alarm level icons, ▲ (Level 1 for flammable and toxic, and O₂ excess), ▲ (Level 2 for flammable and toxic), ▼ (O₂ deficiency), Ⓢ (STEL), or Ⓣ (TWA) will be displayed according to the alarm level for the gas type in question.

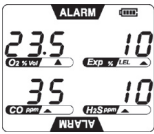
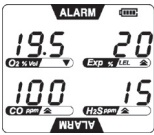
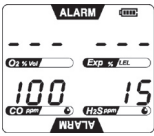
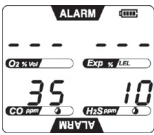
Alarm Type	Level of Significance	Display *	Audible Alarm	Visual Alarm	Vibrating Alarm
Level 1 Alarm	High (for O ₂ excess) Intermediate (for toxic and flammable)		3-tones/ 2-beeps per 1 second	2-flashes per 1 second	once every 2 seconds
Level 2 Alarm	High		5-tones/ 4-beeps per 1 second	4-flashes per 1 second	once every 1 second
STEL Alarm	High		5-tones/ 4-beeps per 1 second	4-flashes per 1 second	once every 1 second
TWA Alarm	High		5-tones/ 4-beeps per 1 second	4-flashes per 1 second	once every 1 second

* Examples shown for default settings of each gas for the MiniMAX4 series.

Note: In latching alarm mode, once an alarm occurs, the audible, visual and vibrating alarms continue to operate even after the atmospheric hazard has cleared. By pressing the ON/OFF button, the alarm will be cleared (after the atmospheric hazard has cleared). Any subsequent alarm will reactivate the audible, visual and vibrating alarms.

Note: In non-latching alarm mode, should the gas alarm occur the detector would enter alarm condition. When the reading returns to a normal level, the audible, visual and vibrating alarms will stop.



Note: If the measured reading exceeds the range of the sensor, the full-scale value will blink.

3-4. GAS EXPOSURE STATUS REVIEW

Caution: No gas will be detected while in the gas exposure status review mode.

The detector records the maximum readings, minimum readings (for oxygen only), STEL and TWA values (for toxic only). While in measuring mode, these can be viewed by pressing the **UP** or **DOWN** button. The first press of the **UP** or **DOWN** button turns on the backlight if it is not already on. The exposure status can be scrolled through in the order of **High Peak** (▲), **Low Peak** (▼), **STEL** (⦿), and **TWA** (⦿), followed by **Calibration Due Date**, **Current Date**, and Current Time by pressing the **UP** button or in reverse order by pressing the **DOWN** button.

Note: If no button is pressed within 10 seconds, the detector will revert back to the measuring mode.

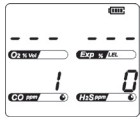
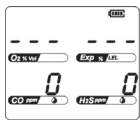
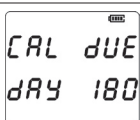
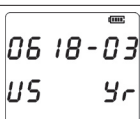
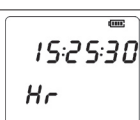



Gas Exposure Status	Display	Description
High Peak ▲		Maximum gas exposure levels encountered during work shift. <i>Note: To clear the high peak values, press the ON/OFF button while the values are displayed.</i>
Low Peak ▼		Minimum oxygen level encountered during work shift. <i>Note: To clear the low peak value, press the ON/OFF button while the value is displayed.</i>
STEL ⦿		Short-term exposure limit based on a 15-minute period. <i>Note: The STEL value can be cleared manually when the power is turned on or will be cleared automatically if the power is kept turned off for more than 15 minutes.</i>
TWA ⦿		Time-weighted average based on an 8-hour workday. <i>Note: The TWA value can be cleared manually when the power is turned on or will be cleared automatically if the power is kept turned off for more than 8 hours.</i>
Calibration Due Date		Remaining days until next SPAN calibration
Current Date		Current date in MM DD - YY format (US) or DD MM - YY format (EU)
Current Time		Current time in HH:MM:SS format (24 hour format)

* Examples shown for the status review for the MiniMAX4 series

3-5. CONFIDENCE FLASH/BEEP

If selected, the detector will emit a flash and a beep once every 30 seconds to indicate that the detector is operating. The user can select whether this feature is activated or not, and whether it is an audible signal, visual signal or both (See Section 5 Set-Up Mode). If any error or fault is detected, the confidence flash/beep will stop. The factory default is no confidence flash/beep.

3-6. LOW BATTERY

When the detector's battery level reaches a preset level, it will warn the user that the battery is low and needs replacing by generating a beep and flashing the alarm LED once every 5 seconds. Also, the Test Fail icon  will be displayed and the Low Battery icon  and Test Pass icon  will blink alternately. When the battery is finally exhausted, the Test Fail icon  and Low Battery icon  will blink simultaneously with seven beeps and "bAttEry oFF" will be displayed. Pressing the **ON/OFF** button will turn the detector off completely.

After a low battery alarm, the batteries should be replaced as shown in Section 6-1 Replacing the Batteries.

3-7. DATA LOGGING

Warning: Do not install or remove the memory card in the detector or attempt to read, download or write to the memory card using a memory card reader and/or computer in potentially hazardous atmospheres.

Warning: Do not remove the batteries from the detector while the power is on. This can cause fatal damage to the optional memory card if installed.

Before you can begin data logging, you will need to purchase a memory card and a card reader. You will also need PC software, which you can either download from our web sites (www.lumidor.com for MiniMAX4 series and www.zelana.com for ImpulseX4 series), or you can purchase it on CD. (See Section 7 Optional Accessories.)

Warning: Use only approved memory cards, part # 2566-0435, which are available from Honeywell Analytics. Use of any other manufacturer or type will violate intrinsic safety requirements.

Warning: Do not use a memory card containing non-X4 data. The detector or card reader will either erase non-X4 data or reformat the memory card.

For memory card readers, the suggested part numbers are listed below and can be purchased from Honeywell Analytics or from a local source of your choice.

Suggested Card Readers: (Indicated items will read both MMC (MultiMediaCard) and SD (SecureDigital) cards.)

- Sandisk # SDDR-93
- DAZZLE # DM22200

Note: A number of memory card readers compatible with the listed parts above will work with the memory cards used in the detector

When the detector is turned on, it will check the memory card in the memory card slot if card is installed. When a properly formatted blank memory card is detected, the Data Logging icon  will be displayed in the measuring mode which indicates that data is being logged.

Note: The detector only supports FAT16 format for the memory card.

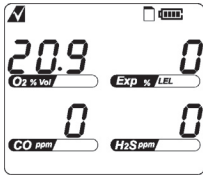

The detector will start data logging automatically and save the gas readings at a user-configurable interval. The factory default interval is 60 seconds. (See Section 5 Set-Up Mode.)

Note: Should an alarm be activated while in the data logging mode, varied alarm sound may be generated, as the detector periodically writes data to the memory card.

When the memory card becomes full in the measuring mode, the detector will stop data logging and the Data Logging icon  will blink which indicates that no data is being logged.

Note: The detector cannot format the memory card.

Warning: The detector ignores the write-protect feature of the SD memory card.

Warning: When the Data Logging icon  is either blinking or not displayed, it indicates that no data is being logged.

To install or remove the memory card, see Section 6-2 Installing or Removing the Memory Card.

4. CALIBRATION

Note: Calibration should be carried out with fresh batteries.

Warning: Calibration cannot be carried out when the detector emits a low battery alarm.

The calibration mode menu structure is shown in Appendix A (A-1 and A-2).

4-1. CALIBRATION PROMPT

To enter calibration mode while in measuring mode, press the **ON/OFF** button 2 times.



A "CAL no" prompt will be displayed.

Press the **UP** or **DOWN** buttons to alternate between "no" or "YES" and press the **ON/OFF** button to select.



or



When "no" is selected, the calibration will be aborted. When "YES" is selected, the calibration will be performed.

4-2. ZERO CALIBRATION (SPAN CALIBRATION FOR OXYGEN)

ZERO calibration must be performed in a clean atmosphere. It is recommended that a ZERO calibration be performed daily or after any gas alarm.

- The detector will initiate a ZERO calibration showing a blinking ZERO Calibration icon and a countdown from '020' to '000'.

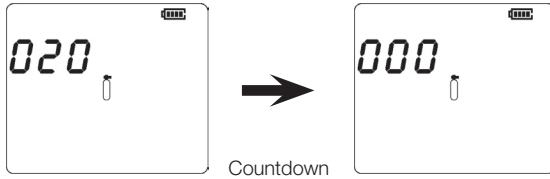

- When the ZERO calibration has been completed successfully for all sensors, the Test Pass icon will blink for 5 seconds.
- If the ZERO calibration fails for one or more sensors, the detector will give a single beep and a single flash and both the Test Pass icon and Test Fail icon will blink for 5 seconds.
- If the ZERO calibration fails for all sensors, the detector will give a single beep and a single flash and only the Test Fail icon will blink for 5 seconds.

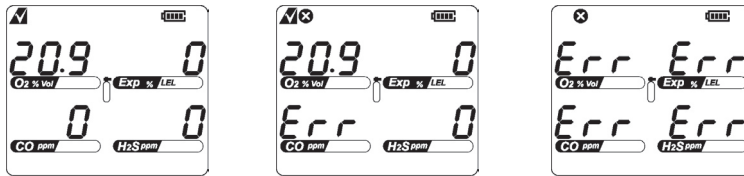

All Pass

Some Pass/Fail

All Fail

Note: If any sensor has failed, repeat the ZERO calibration ensuring that the detector is in fresh air. If a second failure occurs, contact Honeywell Analytics or their agent.

Warning: Under proper calibration procedures, repetitive calibration failures could indicate that the sensor is either approaching its end of life, or it has been seriously contaminated, or both.

4-3. SPAN CALIBRATION (FOR FLAMMABLE AND TOXIC SENSORS ONLY)

Calibrate the detector at least every 6 months (CH₄, CO, H₂S), depending on use and exposure to contaminants. User can perform the SPAN calibration with 4 gases at the same time or with a single gas. When SPAN calibration is performed with a single gas, the detector detects the supplying gas automatically.

To carry out the SPAN calibration, the user needs the following accessories, which are available from Honeywell Analytics (See Section 7 Optional Accessories):

- Calibration gas cylinder of known concentration (multi-gas mix) as follows:

Gas	Recommended Calibration Gas Concentration	Concentration Range Calibration Gas
CH ₄	50% LEL	20 ~ 50% LEL
CO	50 ppm	50 ~ 200 ppm
H ₂ S	25 ppm	20 ~ 50 ppm

- A flow regulator supplying the gas at 300 mL/min flow rate
- Tubing for use between the regulator and the flow adaptor

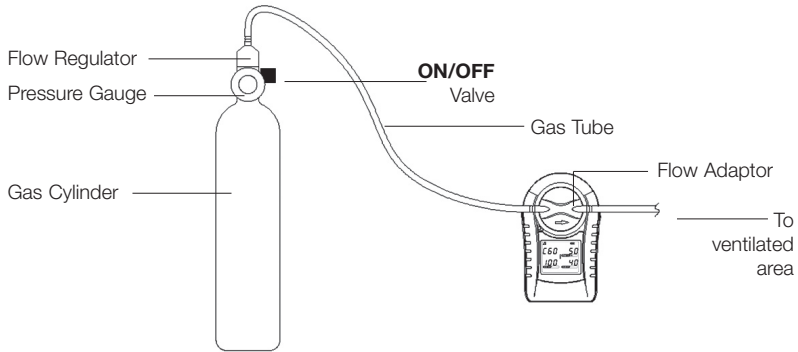

Carry out the ZERO calibration procedure as described in Section 4-2 Zero Calibration (Span Calibration for Oxygen).

- Only if the ZERO calibration is successful can a SPAN calibration be performed.
- At the end of the ZERO calibration procedure, the **ON/OFF** button must be pressed and held continuously for 5 seconds in order to proceed to SPAN calibration while the Test Pass icon  is still blinking. If pass code protection is activated proceed to Section 4-3-1 Pass Code Input, otherwise proceed to Section 4-3-2 Span Gas Information.
- If no actions are performed at the end of the zero calibration the detector will return to measuring mode.

4-3-1. PASS CODE INPUT

If the Pass Code Protection feature has been activated, the detector prompts the user to enter the pass code.

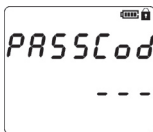

Press the **UP** or **DOWN** buttons to scroll to the current pass code. For fast scrolling, press and hold the **UP** or **DOWN** buttons. When the current pass code is displayed, press the **ON/OFF** button to enter the pass code.

Note: If the user fails to input the correct pass code 3 times consecutively, the detector will return to measuring mode.

Note: For lost pass code, contact Honeywell Analytics or their agent.

4-3-2. SPAN GAS INFORMATION

The SPAN gas information will be displayed.

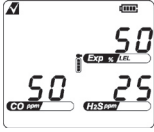

Only the gas label and SPAN gas concentration of the flammable and/or toxic sensor(s) that passed the ZERO calibration will be shown on the LCD display.

4-3-3. SPAN GAS SETTING

The SPAN gas information will be displayed.

- The span gas concentration can be changed by pressing the **ON/OFF** button within 10 seconds during the display of the span gas information.
- The user can adjust the value with the **UP** or **DOWN** buttons and accept it by pressing the **ON/OFF** button.
- To scroll to a gas sensor without altering current values, press the **ON/OFF** button without pressing the **UP** or **DOWN** buttons.

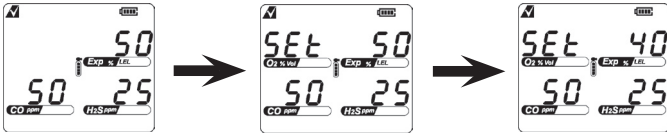

Select Exp Gas

Change Concentration
from 50 to 40 %LEL

4-3-4. GAS SEARCH AND COUNTDOWN

For SPAN calibration, apply the gas to the detector when the SPAN Calibration icon  blinks. The detector will monitor sensor signals for supplied gas.

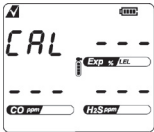

Gas Searching

If the detector detects one or more gases, it displays the expected concentration for the detected gas(es) and starts a 60 second countdown for SPAN calibration.



The detector detects gas and executes SPAN calibration

Note: If no gas is detected within 30 seconds, the detector will give a single beep and a single flash, indicate an error "Err" for all gases on the LCD display, blink the Test Fail icon ☒ for 5 seconds, and then exit calibration mode.

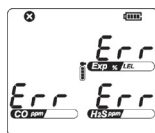

No gas detected

4-3-5. SPAN CALIBRATION RESULT

If one or more gases are detected, the detector will display the SPAN calibration results after the countdown.

- When the SPAN calibration has been completed successfully for all sensors, the Test Pass icon ☑ will blink for 5 seconds.
- If the SPAN calibration has failed for some sensor(s), the detector will give a single beep and a single flash and indicate an error "Err" for the gas type in question on the LCD display. Both the Test Pass icon ☑ and the Test Fail icon ☒ will blink for 5 seconds.
- If the SPAN calibration has failed for all sensors, the detector will give a single beep and a single flash and indicate an error "Err" for all gases on the LCD display. The Test Fail icon ☒ will blink for 5 seconds.

Note: If the span calibration fails, the calibration of failed sensor(s) will remain as it was before the span calibration was attempted. Repeat the SPAN calibration ensuring that the calibration gas used is of the correct concentration, there is sufficient gas in the cylinder and the flow rate is correct. If a second failure occurs, contact Honeywell Analytics or their agent.

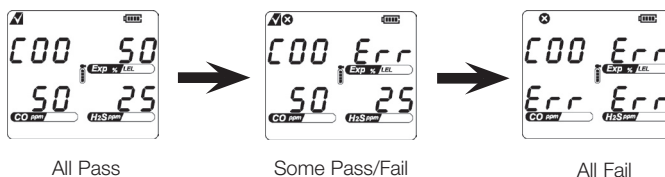

After SPAN calibration, the detector saves the successful SPAN calibration value(s) and exits SPAN calibration mode unless the **ON/OFF** button is pressed and held within 5 seconds. If the **ON/OFF** button is pressed and held for 5 seconds while the Test Pass icon ☑ and/or Test Fail icon ☒ are still blinking (depending on the calibration result), the detector will save successful SPAN calibration value(s) and repeat the SPAN calibration procedure.

5. SET-UP MODE

Caution: No gas will be detected while in the set-up mode.

The detector is provided with a means for the user to configure the following aspects of its operation:

- **Latching / Non-latching alarms**
Changes the alarm latch state between latching and non-latching. If the level 1 and level 2 alarms are set to latching, the audible and visual alarms continue until the user acknowledges the alarm. If the level 1 and level 2 alarms are set to non-latching, the audible and visual alarms stop when the gas concentration comes down to the level below the alarm set points (or the gas concentration comes up to the level above the level 2 alarm in the case of oxygen). (Factory default is "oFF" for non-latching alarms.)
- **Alarm 1 set point**
Adjusts the level 1 (flammable and toxic low, O₂ excess) gas alarm set point. A gas concentration at or above this point generates an alarm instantly.
- **Alarm 2 set point**
Adjusts the level 2 (flammable and toxic high, O₂ deficiency) gas alarm set point. A gas concentration at or below this point (for oxygen) or at or above this point (for flammable and toxic) generates an alarm instantly.
- **STEL alarm set points**
Adjusts the short term exposure limit alarm set points.
- **TWA alarm set points**
Adjusts the time-weighted average alarm set points.
- **Confidence signals**
Sets the confidence signal as a beep ("b--"), flash ("--F"), beep and flash ("b-F"), or none ("--"). (Factory default is "---" for disabling the confidence signals.)
- **Pass code protection**
Enables or disables the pass code protection and changes the current pass code as required. (Factory default pass code protection setting is "oFF". The factory default pass code is "000".)

Note: To proceed, the detector prompts the user to enter the current valid pass code.

- **Data logging interval**
Sets the data logging interval to 5, 10, 30, 60, 120, or 180 seconds. (Factory default is "60".)
- **Current date**
Sets the current date. (Factory default is US format for MiniMAX4 series and EU format for ImpulseX4 series.)

Note: The order is month, day, then year in the US format. The order is day, month, then year in the EU format.

- **Current time**
Sets the current time in the order of hours, minutes, then seconds.

Note: Hour is expressed in a 24-hour format (eg. 3:42 PM = 15:42).

- **%LEL / %Vol (for flammable)**
Measure the flammable gas concentration in the unit of %LEL or %Vol. (Factory default is “%LEL”.)
- **Correction factor (for flammable)**
Sets the %Vol concentration equivalent to the 100% LEL of the target gas (Refer to Appendix B-2 for more information). (Factory default is “5.00” for MiniMAX4 series and “4.40” for ImpulseX4 series.)
- **Calibration due date**
Sets the interval (30 ~ 180 days) between span calibrations. (Factory default is “180”.)
- **User ID number**
Sets the user ID number (001 ~ 999). (Factory default is “001”.)
- **Sensor enable (on) / disable (off)**
Enables or disables installed sensors.

Note: Disabling one or more installed sensors configures the detector to a 1, 2, or 3-gas unit. No protection is provided for the gas targeted by the disabled sensor(s).

5-1. ENTERING THE SET-UP MODE

While in measuring mode, press and hold both the **UP** and **DOWN** buttons simultaneously for 3 seconds to enter the set-up mode. The detector will generate a single beep, display the [] icon, generate a beep, and then enter the set-up mode. If the Pass Code Protection feature has been activated, the detector prompts the user to enter the pass code. (See Section 4-3-1 Pass Code Input.)

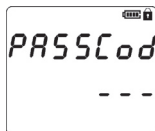

Note: If the user fails to input the correct pass code 3 times consecutively, the detector will return to measuring mode

5-2. CHANGING THE DETECTOR SET-UP

The set-up mode menu structure is shown in Appendix A (A-3, A-4, A-5, and A-6).

In set-up mode, pressing the **UP** or **DOWN** buttons scrolls to a function and pressing the **ON/OFF** button selects the function, so that the displayed value or status may be changed.

For each value/status, pressing the **UP** button increases the displayed value or scrolls through the status, pressing the **DOWN** button decreases the displayed value or scrolls through the status. Pressing the **ON/OFF** button accepts the displayed value or status.

*Note: The previous value or status can be restored by pressing the **UP** and **DOWN** buttons together instead of pressing the **ON/OFF** button.*

Once the displayed value or status has been changed and accepted, the new value or status is stored within the detector.

5-3. EXITING THE SET-UP MODE

In set-up mode, if no button is pressed within 20 seconds, or both the **UP** and **DOWN** buttons are pressed together and held for 2 seconds, the detector will revert back to the measuring mode.

6. MAINTENANCE

6-1. REPLACING THE BATTERIES

Warning: Substitution of components may impair intrinsic safety.

Warning: Do not replace the batteries in potentially hazardous atmospheres.

Warning: Use only approved 'AA' Alkaline Batteries, Energizer® E91 or EN91. Use of any other manufacturer or type will violate intrinsic safety requirements.

Warning: Use only two new batteries of the same type, when replacing the batteries.

Warning: Replace batteries as soon as the detector emits a low battery alarm.

Warning: Do not remove the batteries from the detector while the power is on. This can cause fatal damage to the optional memory card if installed.

Warning: If the rubber boot is removed for servicing or any other reason, it must be replaced before the instrument is placed back in service.

- Turn the detector off.
- Lift the locking tab on the bottom of the detector and turn it 90° counterclockwise.
- Pull the battery holder with locking tab out of the detector.
- Remove the old batteries and insert new batteries ensuring correct orientation as indicated on the molding. Ensure they are of the correct type to comply with the intrinsic safety requirements.
Note: Dispose of batteries according to local or national regulations.
- Insert battery holder into the detector, turn the locking tab 90° clockwise, and return the locking tab to its original position.

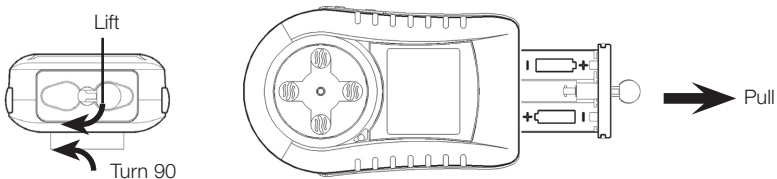

Note: Periodically inspect the battery holder terminal contacts for build up of dirt. Remove any debris using soft cloth and industrial alcohol.

6-2. INSTALLING OR REMOVING THE MEMORY CARD

Warning: Do not install or remove the memory card in the detector or attempt to read, download or write to the memory card using a memory card reader and/or computer in potentially hazardous atmospheres.

Warning: Use only approved memory cards, part # 2566-0435, which are available from Honeywell Analytics. Use of any other manufacturer or type will violate intrinsic safety requirements.

- Turn the detector off.
- Remove the battery holder from the detector. (See Section 6-1 Replacing the Batteries.)
- To remove the memory card from the detector, press on its edge until a 'click' sound is heard, which indicates the memory card has been released. The memory card can now be pulled out from the detector.
- To install the memory card, insert it into the card slot and press on its edge until a 'click' sound is heard, which indicates that it is secured in the card slot. Pay attention to the memory card direction (see diagram below).
- Insert the battery holder into the detector. (See Section 6-1 Replacing the Batteries.)

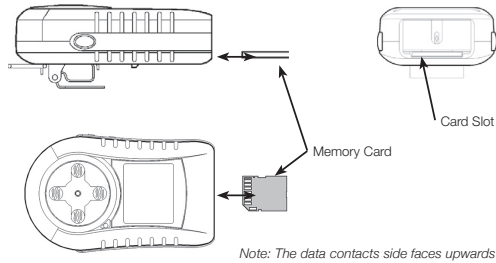

6-3. CLEANING

Warning: Do not use solvents, soap, polishes and any product containing silicon compounds to clean the detector as these can cause damage to the sensors.

- Clean the exterior of the detector with a clean damp cloth.
- Clean the sensor grilles with a soft brush.

6-4. REPLACING THE EXPIRED SENSOR

If the sensor reaches the end of its recommended life, contact Honeywell Analytics or their agent to arrange sensor replacement service.

7. OPTIONAL ACCESSORIES

Warning: Do not install or remove the memory card in the detector or attempt to read, download or write to the memory card using a memory card reader and/or computer in potentially hazardous atmospheres.

Part No.	Description
2566-0429	Field case
2655-0428	Belt clip
2566-0446	Hand aspirator kit with in-line filter and 10 m sample tube
2302B0828	10 m (30') sample tube with in-line filter
2303B0845	In-line filter pack of 10
2303B0846	Ball float
402-190-120	Tubing (2 m/6')
2302B0847	1 m (3') sample probe
2566-0427	10 m (30') sample tubing with ball float
GFV243	Calibration gas (CH ₄ 50% LEL/CO 50 ppm/H ₂ S 25 ppm/Balanced Air) 34 Liter
235-285-085	0.3 L/min flow regulator
2566-0435	Spare memory card for data logging
2566-0436	(*) Desktop USB memory card reader
2566-0437	Data log graphing and reporting software (CD)
2566K0438	(*) Data logging kit includes memory card, memory card reader and data log graphing and reporting software CD
2566-0442	Interactive training guide software / X4 simulator (CD)
2566K0440	Confined space kit for bump test with carrying case
2566K0441	Calibration kit (MAX-KIT#1-MINI) includes 34L cylinder (50% LEL, CH ₄ , 50ppm CO, 25ppm H ₂ S, balance air)
Test-1A	Bump gas cylinder (O ₂ , LEL, CO, H ₂ S, Bal. N ₂)

Warning: The items indicated above with an asterisk () are not certified intrinsically safe and must not be used in potentially hazardous atmospheres.*

See Section 1-4 Standard Accessories for the part numbers of the standard (included) items.

For inquiry see the Contacting Honeywell Analytics section on page 6.

8. SYSTEM CONFIGURATION OPTIONS

8-1. SYSTEM CONFIGURATIONS FOR THE MINIMAX4 SERIES

Variant	Description	Part Number
1	4 gas MiniMAX4 with O ₂ , Flammable, CO, H ₂ S sensors	MiniMAX-4-OFCHA
2	3 gas MiniMAX4 with O ₂ , Flammable, CO sensors	MiniMAX-3-OFCHA
3	3 gas MiniMAX4 with O ₂ , Flammable, H ₂ S sensors	MiniMAX-3-OFXHA
4	2 gas MiniMAX4 with O ₂ , Flammable sensors	MiniMAX-2-OFXXA
5	1 gas MiniMAX4 with Flammable sensor	MiniMAX-1-XFXXA
6	1 gas MiniMAX4 with O ₂ sensor	MiniMAX-1-OXXXXA

8-2. SYSTEM CONFIGURATIONS FOR THE IMPULSEX4 SERIES

Variant	Description	Part Number
1	4 gas MiniMAX4 with O ₂ , Flammable, CO, H ₂ S sensors	ImpulseX4-OFCHA
2	3 gas MiniMAX4 with O ₂ , Flammable, CO sensors	ImpulseX3-OFCHA
3	3 gas MiniMAX4 with O ₂ , Flammable, H ₂ S sensors	ImpulseX3-OFXHA
4	2 gas MiniMAX4 with O ₂ , Flammable sensors	ImpulseX2-OFXXA
5	1 gas MiniMAX4 with Flammable sensor	ImpulseX1-XFXXA
6	1 gas MiniMAX4 with O ₂ sensor	ImpulseX1-OXXXXA

For inquiry see the Contacting Honeywell Analytics section on page 6.

APPENDIX A

A-1. CALIBRATION MODE MENU STRUCTURE 1/2

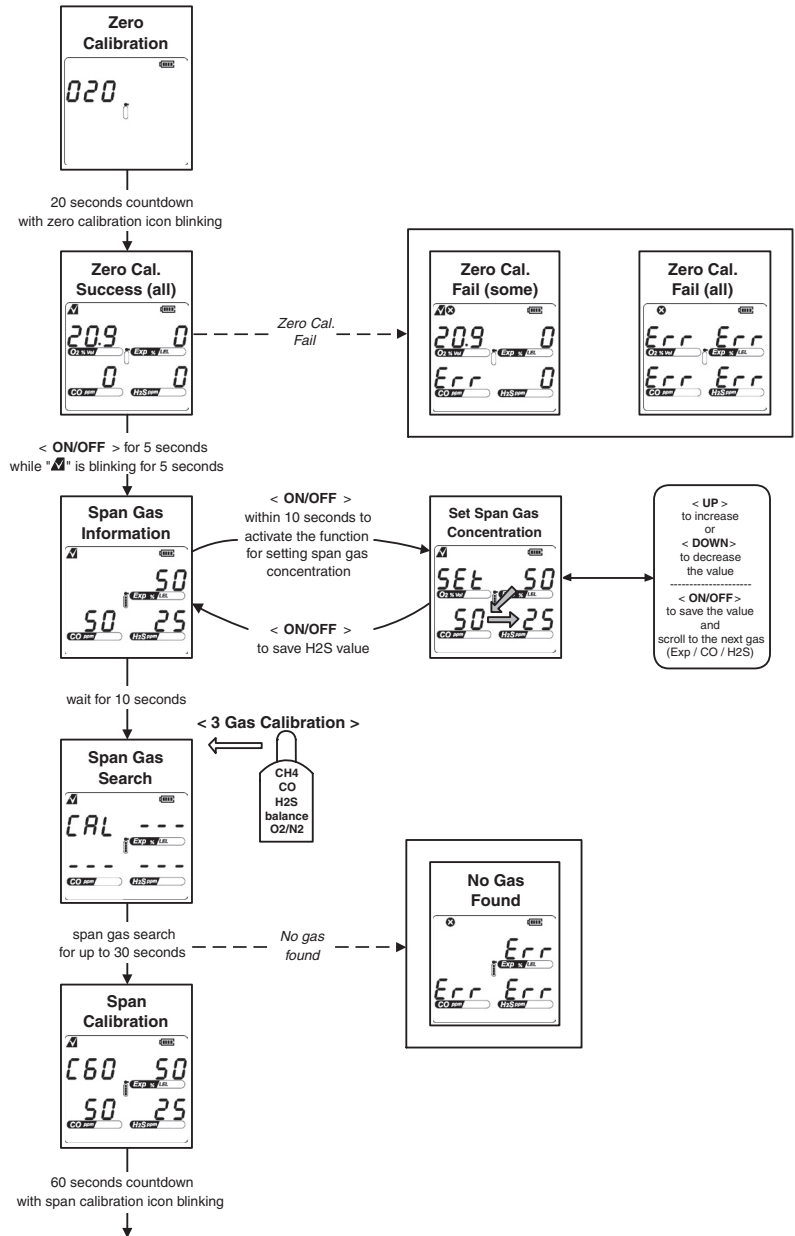

A-2. CALIBRATION MODE MENU STRUCTURE 2/2

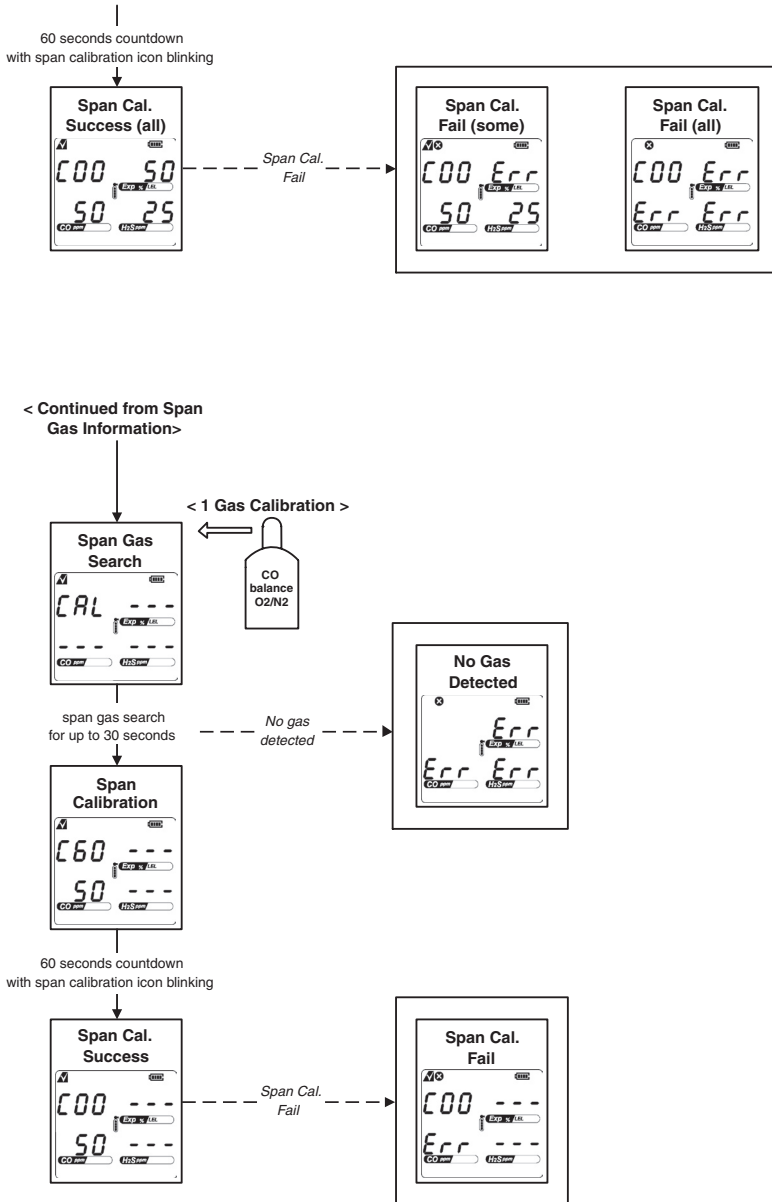

A-3. SET-UP MODE MENU STRUCTURE 1/4

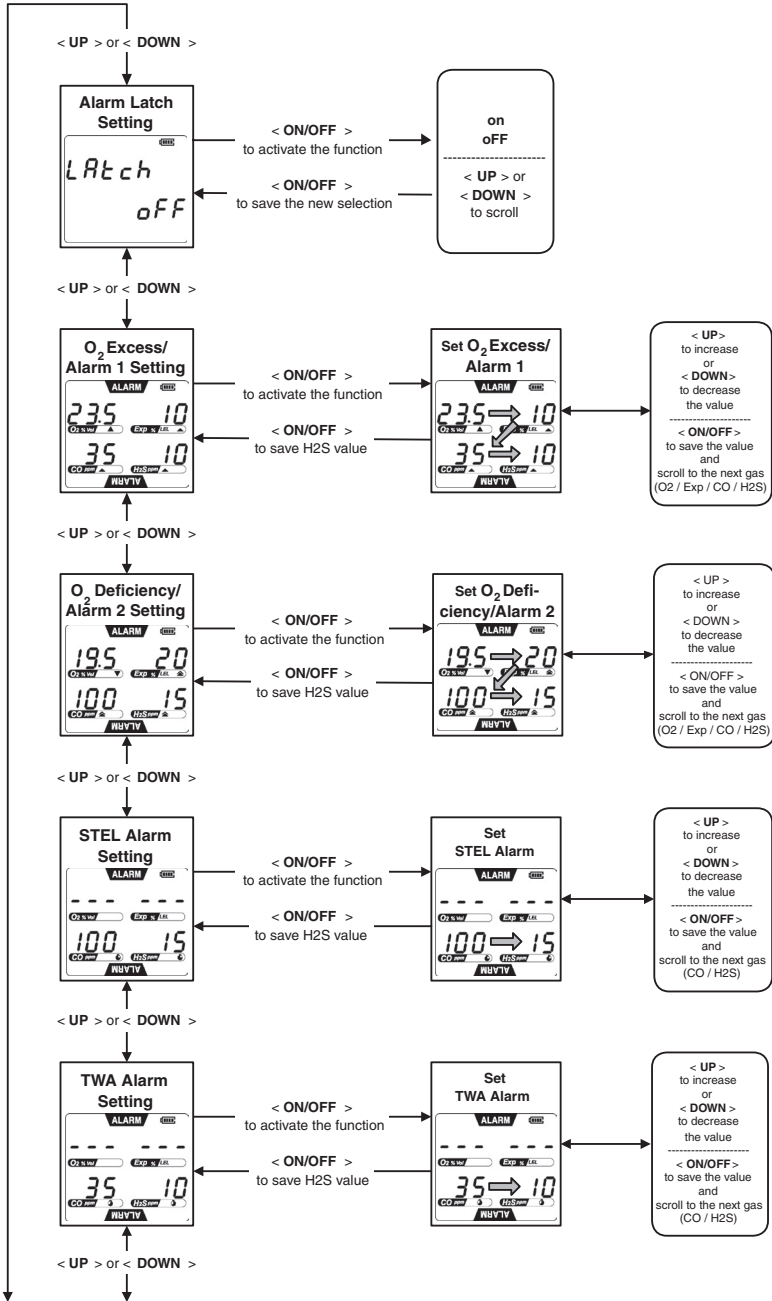

A-4. SET-UP MODE MENU STRUCTURE 2/4

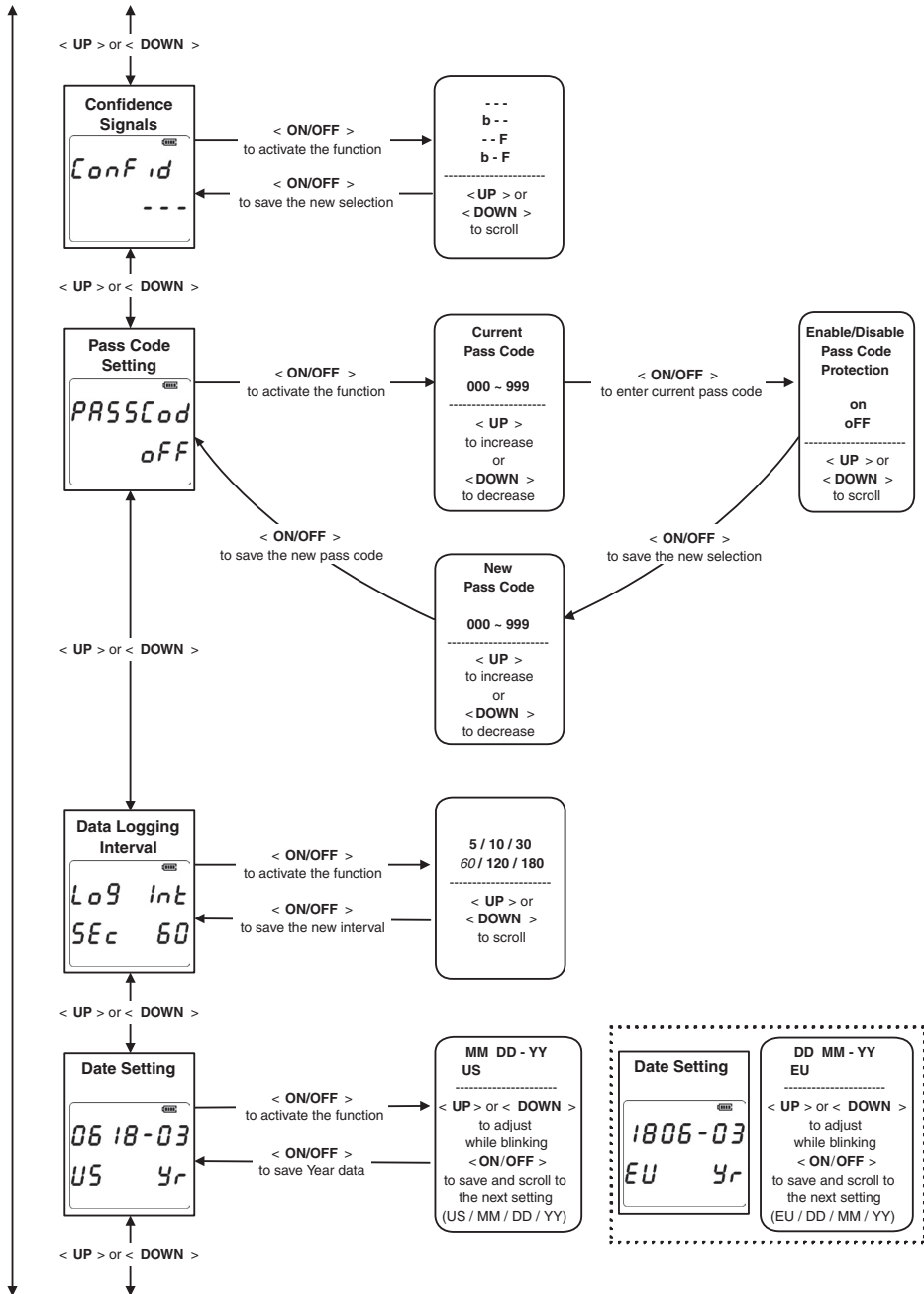

A-5. SET-UP MODE MENU STRUCTURE 3/4

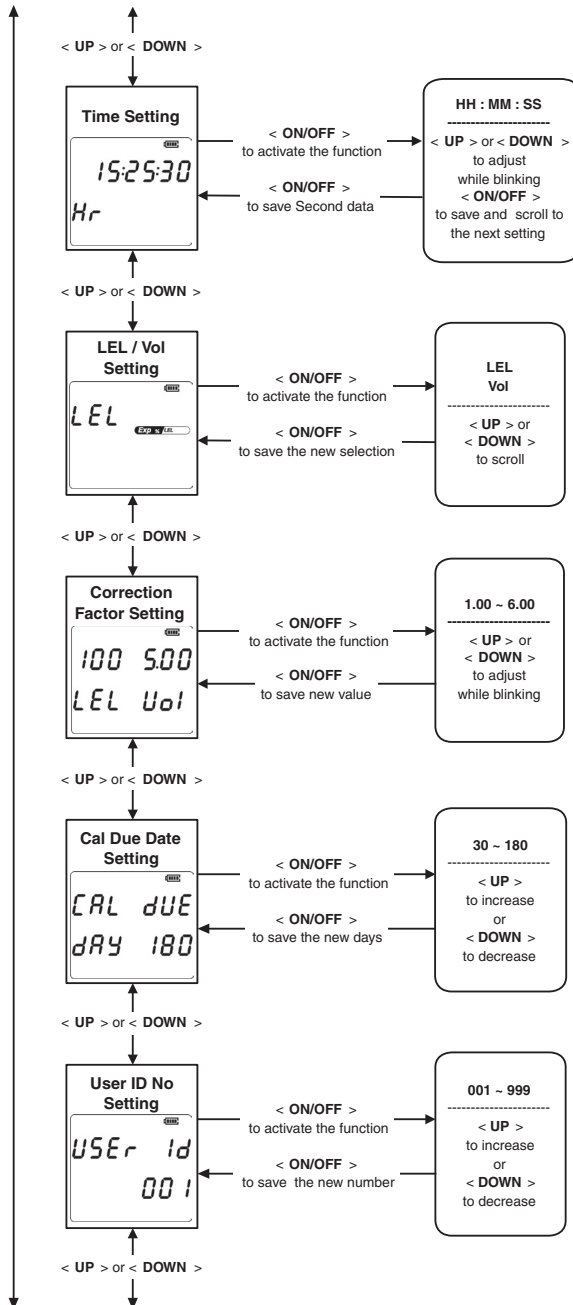

A-6. SET-UP MODE MENU STRUCTURE 4/4

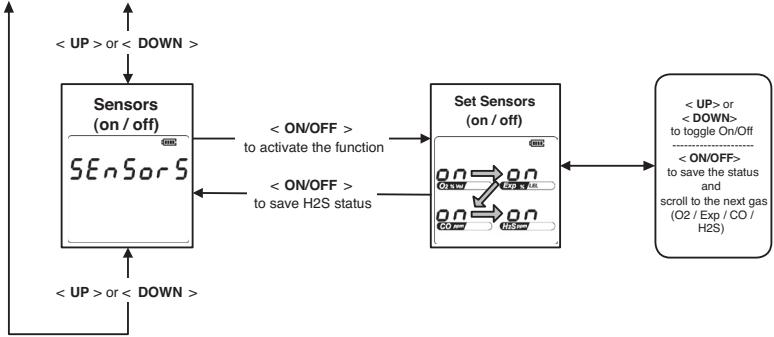

APPENDIX B

B-1. SENSOR CROSS-SENSITIVITY

B-1-1. H₂S AND CO SURECELL CROSS-SENSITIVITY

The H₂S and CO sensors are designed to be gas specific, minimizing the effects of common cross-interfering gases. The table below summarizes the effect of various gases on the carbon monoxide and hydrogen sulfide sensors.

Gas Applied	H ₂ S Response (ppm)	CO Response (ppm)
Acetone (1000 ppm)	0	0
Acetylene (40 ppm)	0	80
Ammonia (50 ppm)	0	0
Carbon Monoxide (50 ppm)	0	50
Carbon Dioxide (5000 ppm)	0	0
Chlorine (0.5 ppm)	0	0
Ethanol (2000 ppm)	0	3
Ethylene (100 ppm)	0	85
Hydrogen (100 ppm)	0	20
Hydrogen Sulfide (10 ppm)	10	0
Iso-Propanol (200 ppm)	0	0
Nitric Oxide (25 ppm)	0	4
Nitrogen Dioxide (3 ppm)	0	0.5
Sulfur Dioxide (2 ppm)	0	0

B-1-2. O₂ CROSS-SENSITIVITY

Gas Applied (%vol)	O ₂ Response
Hydrogen (100% vol)	-9
Methane (100% vol)	0
Nitrogen Dioxide (25 ppm)	0

B-1-3. FLAMMABLE CROSS-SENSITIVITY

Note: The flammable sensor requires O₂ to properly operate. Display concentration will drop with low levels of O₂.

- There is variability in sensor cross-sensitivity between methane and other flammable compounds. Therefore, if the detector is calibrated to methane, the reading when other flammable gases are detected will be subject to variation.
- For more accurate detection of non-methane gases, the detector should be calibrated to the targeted gas desired. In this instance, the reading obtained when methane is detected may be subject to inaccuracy.

Warning: The flammable sensor's sensitivity can be adversely affected by exposure to certain substances called "poisons". Sulfur compounds, phosphorus containing compounds, halogens, silicone or lead containing compounds are example of such poisons. Every effort should be made to avoid exposure to these substances. When the detector is exposed to such substances, a check should be performed on the flammable sensor to verify its accuracy and a calibration performed if necessary.

Warning: Extended exposure of the detector to certain high concentrations of flammable gases stress the flammable detector element, which can seriously affect its performance. If an alarm occurs due to high concentration of flammable gases, recalibration should be performed, or if needed, the sensor replaced.

Warning: Do not expose the detector to electrical shock and/or severe mechanical shock. When the detector is exposed to such shocks, a check should be performed on the sensors to verify accuracy (and a calibration performed if necessary).

B-2. FLAMMABLE LOWER EXPLOSIVE LIMIT

Gas Type	%Vol for 100% LEL (Ref. - NIOSH: 2002)	%Vol for 100% LEL (Ref. - IEC 7920)
Hydrogen	4.00	4.00
Methane	5.00	4.40
Methanol	5.50	5.50
Ethane	3.00	2.50
Ethanol	3.30	3.10
Propane	2.10	1.70
Butane	1.80	1.40
Pentane	1.50	1.40
Octane	1.00	0.80

Note: Factory default values of the Correction Factor are set to 5.00% Vol for 100% LEL methane for MiniMAX4 series and 4.40% Vol for 100% LEL methane for ImpulseX4 series, assuming that the detector is calibrated by methane with relevant concentrations suitable for each standard and going to measure methane gas.

Note: For measuring other gases listed in the table, the detector should be calibrated with the target gas at relevant concentration and the proper Correction Factor needs to be set depending on the standard to be used.

APPENDIX C

C-1. WARRANTY

All products are designed and manufactured to the latest internationally recognized standards by Honeywell Analytics under a Quality Management system that is certified to ISO 9001.

As such, Honeywell Analytics warrants its products against defective parts and workmanship and will repair or (at its option) replace any detectors, which are or may become defective under proper use within 24 months from the date of first turn-on provided this takes place prior to the 'Activate Before' date.

This warranty does not cover disposable batteries or damage caused by accident, abuse, abnormal operating conditions or extreme poisoning of the sensor.

Defective goods must be returned by the Buyer at the Buyer's own expense to Honeywell Analytics premises accompanied by a detailed report stating the nature of the defect. Returned goods must detail the Service Event Number (SE#) clearly on the package and the Buyer shall obtain an SE# by contacting Honeywell Analytics in advance.

If no such report is included then Honeywell Analytics reserves the right to charge an investigative fee (prices available upon request) before any repair or replacement is performed.

Honeywell Analytics shall not be liable for any loss or damage whatsoever or howsoever occasioned which may be a direct or indirect result of the use or operation of the Contract Goods by the Buyer or any Party.

This warranty covers detector and parts sold to the Buyer only by authorized distributors, dealers and representatives as appointed by Honeywell Analytics. A warranty claim will only be accepted if a proof of purchase is submitted and all conditions obtained within this Warranty are met. When in the opinion of Honeywell Analytics, a warranty claim is valid, Honeywell Analytics will repair or replace the defective product free of charge and send it or any replacement back.

This warranty supersedes all existing warranty statements and Honeywell Analytics makes no other warranty expressed or implied except as stated above.

The warranties set out in this clause are not pro rata, i.e. the initial warranty period is not extended by virtue of any works carried out there under.

For full statement of warranty terms, please contact Honeywell Analytics.

C-2. ACCURACY STATEMENT

To achieve optimal accuracy, the detector should be periodically supplied with a known concentration test gas, and if the readings are outside of 15% of the applied gas concentration, a span calibration should be performed, under conditions of standard temperature (15°C to 25°C), humidity and pressure.

APPENDIX D

D-1. SPECIFICATIONS

D-1-1. SPECIFICATIONS FOR THE MINIMAX4 SERIES

General	Reusable multi-gas detector for personal protection against flammable, toxic and oxygen gas hazards. Supplied complete with calibration certificate, quick start guide, alkaline batteries (2), tubing, flow adaptor, crocodile clip, and manual.				
Alarm Set Points#					
Gases Detected	Range	Level 1 (Flammable and Toxic Low, O ₂ Excess)	Level 2 (Flammable and Toxic High, O ₂ Deficiency)	STEL	TWA
Flammable (Exp)	0~100% LEL*	10% LEL	20% LEL	n/a	n/a
Oxygen (O ₂)	0~30% Vol	23.5% Vol	19.5% Vol	n/a	n/a
Carbon Monoxide (CO)	0~999 ppm	35 ppm	100 ppm	100 ppm	35 ppm
Hydrogen Sulfide (H ₂ S)	0~250 ppm	10 ppm	15 ppm	15 ppm	10 ppm
* Flammable channel can display gas concentration in %vol units for a range of flammable gases # User configurable					
Sensors	Patented Surecell™ electrochemical and catalytic bead sensing technology for stable and reliable performance in all industrial environments.				
Diagnostics	Self-test of circuitry, battery, LCD, and sensors on start up or on demand. Patented Reflex™ cell check techniques included as standard for toxic channels.				
Display	Ultra clear icon driven backlit LCD displays gas level and detector status. Unique 'flip display' function at the press of a button for added user convenience. High/Low Peak hold facility included with user clear. Time and date.				
User Interface	Intuitive three button operation for detector configuration.				
Audible Alarm	90 db @ 30 cm				
Visual Alarm	High intensity red LEDs combined with red backlight for maximum effect.				
Vibrating Alarm	Supplied as standard				
Operating Temperature	-20°C to +50°C (-4°F to +122°F). TempraSURE™ temperature compensation.				
Humidity	5-95% RH (non-condensing)				
IP Rating	Ingress protection to IP 65				
Approvals	Australia: Ex ia s Zone 0 I/IIC T4				
RFI/EMC	EN50270:1999 and EN55011				
Sensor Life	Minimum of 2 years backed by inclusive 2 year warranty				
Battery Life	14-16 hours with 2 x AA alkaline batteries. (Battery life will be reduced at low temperatures.) Low power audiovisual warning.				
Dimensions	124 mm(H) X 76 mm(W) X 36 mm(D) 4.9" (H) x 3.0" (W) x 1.5" (D)				
Weight	210 g (7.4oz) (without batteries), 258 g (9.1oz) (with batteries)				
Warranty	2 years				

D-1-2. SPECIFICATIONS FOR THE IMPULSEX4 SERIES

General	Reusable multi-gas detector for personal protection against flammable, toxic and oxygen gas hazards. Supplied complete with calibration certificate, quick start guide, alkaline batteries (2), tubing, flow adaptor, crocodile clip, and manual.				
Alarm Set Points#					
Gases Detected	Range	Level 1 (Flammable and Toxic Low, O ₂ Excess)	Level 2 (Flammable and Toxic High, O ₂ Deficiency)	STEL	TWA
Flammable (Exp)	0~100% LEL*	10% LEL	20% LEL	n/a	n/a
Oxygen (O ₂)	0~30% Vol	23% Vol	19% Vol	n/a	n/a
Carbon Monoxide (CO)	0~999 ppm	35 ppm	400 ppm	200 ppm	30 ppm
Hydrogen Sulfide (H ₂ S)	0~250 ppm	10 ppm	40 ppm	10 ppm	5 ppm
* Flammable channel can display gas concentration in %vol units for a range of flammable gases # User configurable					
Sensors	Patented Surecell™ electrochemical and catalytic bead sensing technology for stable and reliable performance in all industrial environments.				
Diagnostics	Self-test of circuitry, battery, LCD, and sensors on start up or on demand. Patented Reflex™ cell check techniques included as standard for toxic channels.				
Display	Ultra clear icon driven backlit LCD displays gas level and detector status. Unique 'flip display' function at the press of a button for added user convenience. High/Low Peak hold facility included with user clear. Time and date.				
User Interface	Intuitive three button operation for detector configuration.				
Audible Alarm	90 db @ 30 cm				
Visual Alarm	High intensity red LEDs combined with red backlight for maximum effect.				
Vibrating Alarm	Supplied as standard				
Operating Temperature	-20°C to +50°C (-4°F to +122°F). TempraSURE™ temperature compensation.				
Humidity	5-95% RH (non-condensing)				
IP Rating	Ingress protection to IP 65				
Approvals	Australia: Ex ia s Zone 0 IIC T4				
RFI/EMC	EN50270:1999 and EN55011				
Sensor Life	Minimum of 2 years backed by inclusive 2 year warranty				
Battery Life	14-16 hours with 2 x AA alkaline batteries. (Battery life will be reduced at low temperatures.) Low power audiovisual warning.				
Dimensions	124 mm(H) X 76 mm(W) X 36 mm(D) 4.9" (H) x 3.0" (W) x 1.5" (D)				
Weight	210 g (7.4 oz) (without batteries), 258 g (9.1 oz) (with batteries)				
Warranty	2 years				

Energizer is a trademark of the Eveready Battery Company, Inc.

Copyright © 2005 Honeywell Analytics, Inc. All rights reserved.

GASTECH AUSTRALIA PTY LTD

24, Baretta Road, WANGARA

WA 6065 Australia.

Int. Phone: +61 8 6108 0000

Int. Fax: +61 8 9408 1868

Email: info@gastech.com.au

Web: <http://www.gastech.com.au>