



CARPARK CARBON MONOXIDE MONITORING SYSTEM

**CONTROL SYSTEM
DOCUMENTATION
AND SERVICE RECORD**

INDEX

1. Introduction
2. Overview
3. Control
4. Testing and Calibration
5. Technical Data

1. Introduction

This document describes the control installation and includes the engineering and operation of the Gastech Carbon Monoxide Monitoring System

The Gastech Carbon Monoxide Monitoring System provides control function and monitoring for carpark exhaust and ventilation systems.

- Conforms to Australian Standard 1668.2
- Remote and local alarms
- Dual exhaust fan speed control
- Variable speed fan control
- Digital display of carbon monoxide levels

An Maxim Direct Digital Controller monitors carbon monoxide concentration, setpoint parameters and equipment output status and faults. All monitored parameters are analyzed and processed as per the points listed within the configuration files to obtain optimum performance.

2. Overview

The Gastech Carbon Monoxide Monitoring and Ventilation Control System is typically located within the carpark space MSSB. It is configured to provide monitoring of 1 – 6 sensors and control for the ventilation fan(s).

A HMI on the Maxim Direct Digital Controller provides maximum carbon monoxide concentrations and alarm annunciation without user intervention. Individual zone Co concentration levels, equipment status and setpoints may be accessed via the function watch pages.

A volt free contact is provided for external security and alarm monitoring.

3. Control

Inputs

CO Monitor 1	Analogue
CO Monitor 2	Analogue
CO Monitor 3	Analogue
CO Monitor 4	Analogue
CO Monitor 5	Analogue
CO Monitor 6	Analogue

Outputs

CPEF Low Speed Enable	Digital
CPEF High Speed Enable	Digital
CPEF VSD Enable	Digital
CPEF VSD Demand	Analogue

The car park space is monitored with 0 -100 ppm Carbon Monoxide (CO) sensors. Dual fan speed and variable fan speed control is provided to suit the required application.

The individual monitored CO concentration levels within the carpark provide a high select control value. The control value is referenced to the CO setpoint for fan duty control. This ensures that the CO concentration within the car park does not exceed the recommended levels of exposure.

2 Speed Fan Duty

When the monitored CO concentration level exceeds the CO low setpoint (8 ppm) for 4 minutes the car park exhaust system low speed fan output will be enabled.

If the CO concentration level continues to rise to the CO high setpoint (24 ppm), the car park exhaust system fan low speed output will be disabled and the fan high speed output enabled. When CO concentration level falls below the CO high setpoint, the car park exhaust system fan high speed output will be disabled and the fan low speed output enabled.

When the CO concentration level falls below the low CO setpoint for 4 minutes and the exhaust system has been enabled for a minimum of 7 minutes, the fan low speed output will be disabled.

Variable Speed Fan Duty

When the monitored CO concentration level exceeds the CO low setpoint (8 ppm) for 4 minutes the car park exhaust system VSD fan output will be enabled.

If the CO concentration continues to rise the VSD output will be proportionally ramped from 0% (low setpoint -8 ppm) to 100% (CO high setpoint -24 ppm).





When the CO concentration level falls below the low CO setpoint for 4 minutes and the exhaust system has been enabled for a minimum of 7 minutes, VSD fan output will be disabled.



A high CO concentration level alarm will be annunciated at 35 ppm after 1 minute.

A volt free normally closed contact is opened on loss of power, controller failure or high CO concentration alarm













Car park CO concentration levels provide logged data for trend and fault analysis.

Maxim Technician Operating Instructions

















There are 6 function keys used to navigate through the Maxim controller. There are four directional keys. Up , down , left  and right .

The “Hash” key  is to escape, and the “Carriage Return”  is used to enter the next level of programming and to save after editing. There are 6 virtual LED’s which represent the 6 digital outputs on the Maxim.

Viewing Watch Pages and Editing User Variables (Eg.Setpoints)

1. Press and hold the  and  together until the “Navigate” screen is displayed.
2. The “Status” mode will flash. Press .
3. The “Watches” mode will then flash. Press .
4. Page 1 will be displayed in the top left hand corner.
5. Press  to view the five watches on that page.
6. Press  to view the next page of watches. There are 5 pages in total.
7. To edit a user variable (Eg. A temperature setpoint of 22.5°C). Use the  and  until the setpoint you want to edit is displayed, and press . To increase and decrease the setpoint press  and . When the desired setpoint is reached, press .
8. To exit the programming mode, press  until the 6 virtual LED’s are displayed.

Editing the Time and Date

1. Press and hold the  and  together until the “Navigate” screen is displayed.
2. Press  to enter the “Clock” mode and then press .
3. The “Set Clock” function will then be flashing. Press .
4. The display will read “ System Time”. Press  to edit the time and date.
5. The hour will flash. Use  and  to adjust the hour. When the correct hour is reached, use  to scroll across to the minutes, press  and  to adjust the minutes. Press  to edit the date, month and year using the  and .
6. When the correct time and date are entered, press . The display will read “System Time”. To exit the programming mode, press  until the 6 virtual LED’s are displayed.

Adding and Editing the Weekly Schedules

1. Press and hold the # and ▲ together until the “Navigate” screen is displayed.
2. Press ▶ to enter the “Clock” mode and press ↵.
3. Use ▼ to enter the “Schedule” edit mode. When the “Schedule” flashes, press ↵.
4. The “Weekly” will flash. Press ↵.
5. You then have the choice to “Add” a weekly schedule, “Edit” a weekly schedule or “Delete” a weekly schedule. Use ▲, ▼, ▶, and ◀ to choose the desired function and ↵.
6. To edit existing schedules, Use ▲ and ▼ to select the required schedule to edit and press ↵.
The hour will flash. Press ▲ and ▼ to change to the required “On” time. Use ◀ and ▶ to edit the minutes, day, and “Off” time and press ↵ to save.
7. Use ▲ and ▼ to edit another weekly schedule, and repeat stages 6 and 7. Remember to save your settings by pressing ↵ when you have finished.
8. Press # to exit the weekly mode.
9. To add a weekly schedule go to the “Add Wkly” mode and press. ↵ (The “Add Wkly” mode is after stage 4 above)

When you have added your schedules and pressed ↵ to save it, then press # to exit the program mode. (When you have totally finished programming, press the # until the 6 virtual LED’s are displayed.)

Adding and Editing the Yearly Schedules

1. Press and hold the and together until the “Navigate” screen is displayed.
2. Press to enter the “Clock” mode, and press .
3. Use to go to the “Schedule” edit mode. When the “Schedule” flashes, press .
4. The “Weekly” will flash. Use until the “Yearly” mode flashes and press .
5. You then have the choice to “Add” a yearly schedule, “Edit” a yearly schedule or “Delete” a yearly schedule. Use , , , to pick the desired function and then .
6. To edit existing schedules, Use and to select yearly schedule (**Do not Press enter yet**). Use the and to then select the required exception schedule to edit, in the selected year and then press .
7. The hour will flash. Press the and to change to the required “On” time. Use the and to edit the minutes, day, year and “Off” time. Press to accept the edited schedule. Do the same with any other schedules you would like to edit.
8. To add a schedule, press until the display shows “Add Yearly”, “Edit Yearly” and “Del Yearly”. Press , , , until the “Add Yearly” is selected. When it flashes, press .
9. The hour will flash. Press the and to change to the required “On” time. Use the and to edit the minutes, day, year and “Off” time. Press to accept the new schedule. Do the same with any other schedules you would like to add.

When you have saved any added and edited schedules, and are ready to exit the programming modes, press until the 6 virtual LED’s are displayed.

Section 2 – Operation

2-1 Introduction

The Maxim Series Digital Controller is designed as a versatile, easy-to-use, state-of-the-art microprocessor. It operates similar to, and contains several elements of, a typical personal computer (PC), including some of the operating keys.

The Maxim Series Digital Controller is configured for its specific application through use of the Innotech Maxim Configuration Software, either at the factory prior to delivery or by the customer after receipt of the equipment. Since each Maxim Series Digital Controller is configured to its own specific application, and since each application is unique, no two Maxim Series Digital Controllers are exactly alike in terms of detailed operating procedures. However, this is not a disadvantage since the Maxim Series Digital Controller is user-friendly and operation of the unit is simple, once the basic operational information is known. This section of the instruction manual provides the following information to familiarise the user with the operation of the Maxim Series Digital Controller:-

- An **Overview of Operation Information** required by the operator – this includes specific operation-related background information; such as descriptions of access levels, methods of accessing data, presentation formats and similar information necessary to the user's understanding of the Maxim Series Digital Controller's operational capabilities.
- A description of the Maxim Series Digital Controller's front panel **Controls and Indicators** – this includes detailed descriptions of what functions the various control keys perform and the significance of the indicator displays, especially the liquid crystal display (LCD) screen.
- **Detailed Operating Procedures** – building upon information covered in previous paragraphs, this part of the section guides the operator step-by-step through an operating scenario for a typical Maxim Series Digital Controller configuration.

NOTE

Some of the paragraphs in this section have been marked by a tick (✓) in the page margin. The ticks identify information or procedures which are of special importance to the operator.

Please note the screen displays used throughout are taken from a typical Maxim I Controller. Where these differ from the Maxim II or III is explained in the text.

2-2 Menu Structure

The LCD screen is the primary method by which Maxim Series Digital Controller output data is presented to the user. Other readout methods, such as through the Maxim Series software or by a modem, are available for monitoring data. However those methods are not within the scope of this manual, and therefore, are not included. This paragraph describes how LCD window readouts are organised into units called pages and the various types of information contained in those pages. More detailed information on the LCD readouts and LED indicator displays are contained elsewhere in this section. The structure of the LCD presentations is shown below and each section is described in the following paragraphs:-

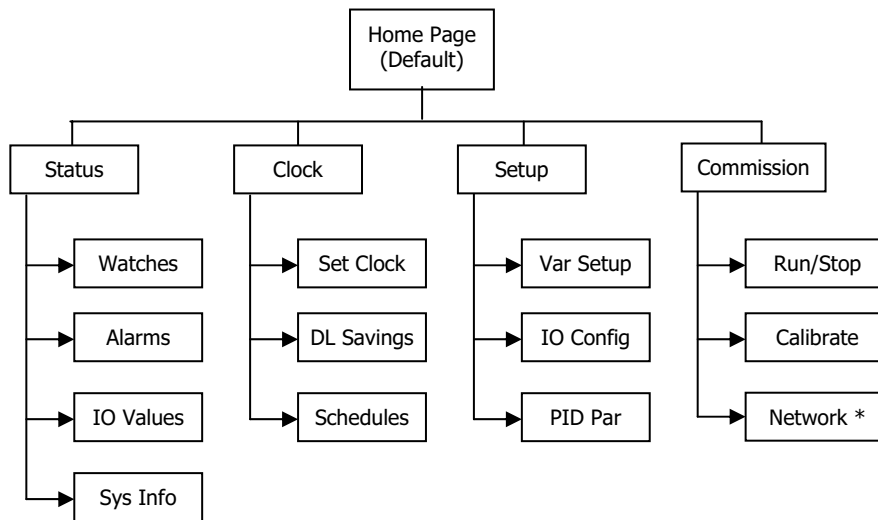

Figure 6 : Maxim Digital Controller Menu Structure

2-3 Home Page

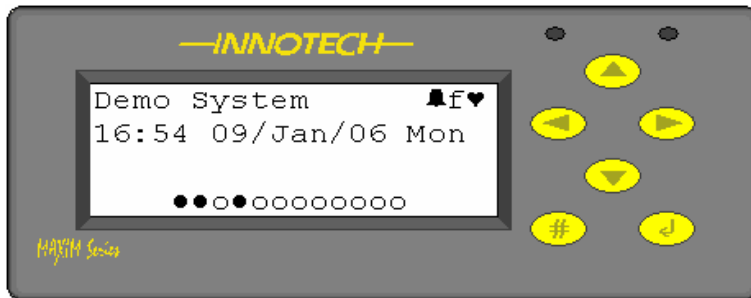



Figure 7 : Home Page Display

The Home Page is the starting and ending point for operation of the Maxim Series Digital Controller. It is the first LCD presentations at start-up of the controller and it is the point at which a user logs on to the Maxim Series Digital Controller. The Home Page is also the point from which the user exits the system when operation is completed.







The LCD screen displays 4 lines of text, defined as follows:-

- Line 1 : is the name of the Maxim Series Digital Controller and is defined in the application program downloaded to the controller.
- Line 2 : shows the current time and date.
- Line 3 : can display Flash Watches which are simple messages caused by an action or operation within the controller. They are displayed on Lines 3 & 4 and conceal the virtual LED's.
To view the status of the LED's in these circumstances press the  button. A more detailed explanation is given in the next section. If Flash Watches are not programmed into the controller, the third line would be blank.
- Line 4 : shows the status of the controller's digital outputs. Maxim III has twelve (12) virtual LED's displayed; Maxim I and II each have six (6) virtual LED's displayed.

The keypad to the right of the LCD display allows the user access to the menu tree in the device and provides all the necessary key functions required to operate the controller.

The key pad functions are generally defined as follows:-

Keypad Functions –

-  Up – Moves cursor up / Increase – used to increase value (eg. say, a setpoint)
-  Down – Moves cursor down / Decrease – used to decrease value (eg. say a setpoint)
-  Left – Moves cursor left or pages to the left
-  Right – Moves cursor right or pages to right
-  Enter/Edit/Accept – moves down a menu level or allows a value to be changed and accepted
-  Exit/Esc – exits from a menu level, escapes changes (unless already saved via Enter button)

A key can have more than one function and this would be shown on the relevant screen when applicable and an example of this can be seen on the next page in the *Navigation* screen.

The icons and symbols that are displayed on the LCD screen from time to time are explained on the next page.

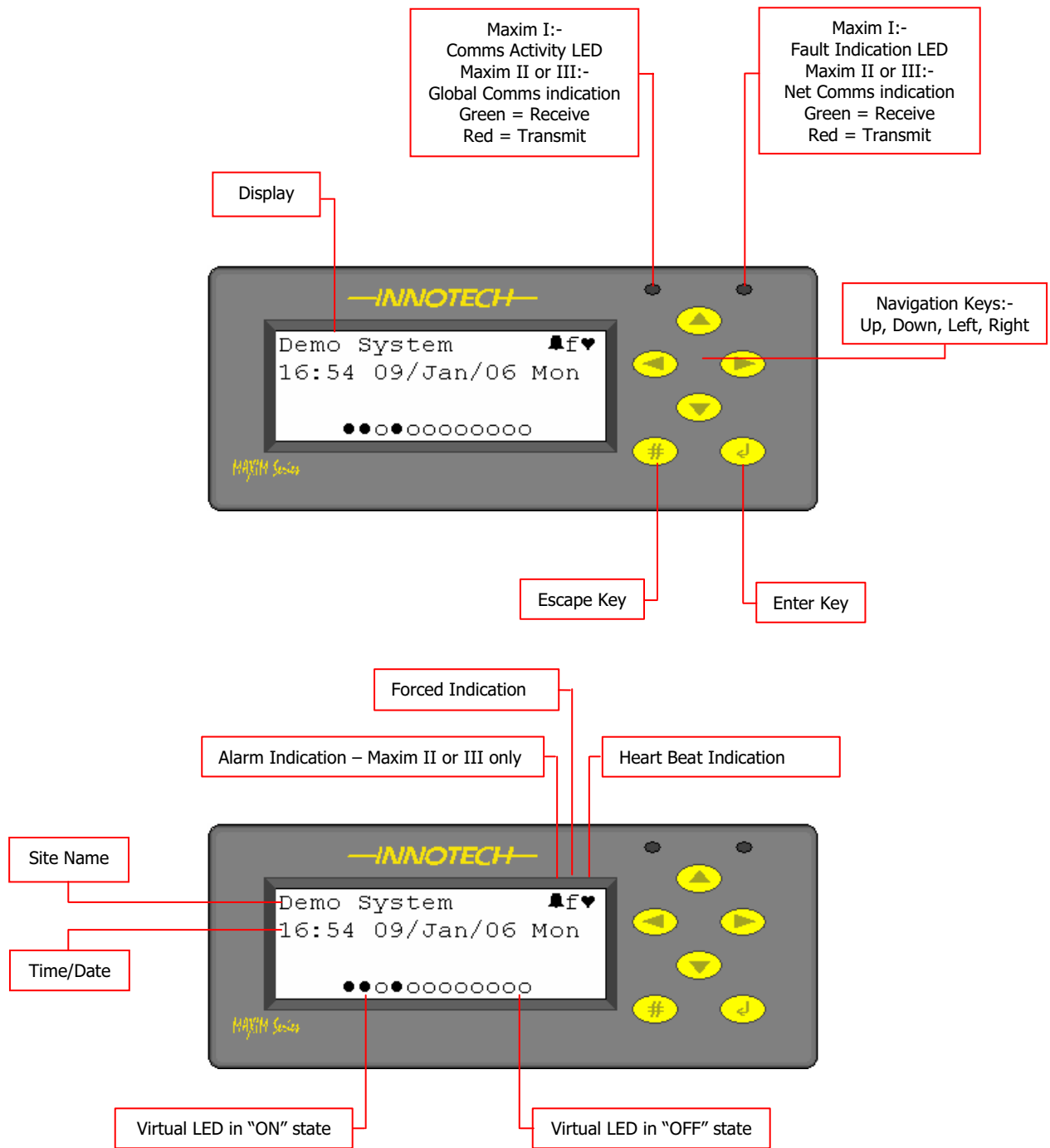

Figure 8 : Front Layout

2-4 Flash Page Watches

When the unit is first configured by the Maxim Configuration (MaxCon) software, watches can be assigned to a page of data called the Flash Page. If flash watches have been pre-configured, they are flashed on the third and fourth lines of the Home Page, at five second intervals. After start-up, the first Flash Watch is displayed for five seconds and then the next Flash Watch is displayed for five seconds, and so on until the cycle is repeated.

Alarms that have the *Display* option marked in the *block* are sent to the display as a flash. Alarm annunciation has priority and overrides the flash page until all alarms are cleared.

The figure below is an example of how Flash Watches are cycled on a typical Home Page.

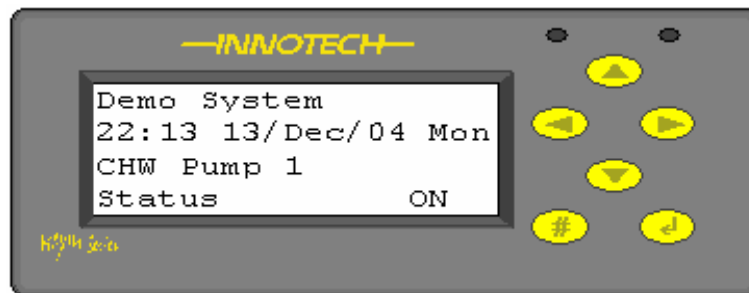

Figure 9 : Flash Page

The Flash Watch feature is especially useful for applications containing many watches; it allows the operator to monitor a range of specified watches without having to access a Watch Page and manually scroll through it. Depending on how the Flash and Watch Pages are configured by the software, an individual watch can be on the Flash Page and on a Watch Page as well. Watch data that would otherwise be editable can be displayed on a Flash Watch but cannot be edited from the Flash Watch.

The maximum numbers of Watches that can be displayed on a flash page are:-

- 5 for MiniMax / Maxim I / II Controllers
- 10 for Maxim III Controllers

2-5 Access Codes

When the controller is configured it is possible to prevent unauthorised access to any of the functions using Access Codes. These can only be set from within the MaxCon Software and are downloaded to the controller during commissioning. The default setting in MaxCon Software is OFF, which means that access codes are ignored. If access codes are enabled, there are two options:-

- *Only Supervisor code required* – If this option is selected access is allowed to the User level without any restrictions but to get to the Supervisor level the user has to enter the appropriate access code (Supervisor code).
- *Both User and Supervisor codes required* – If this option is selected access to both User and Supervisor level is allowed only after the appropriate access code is entered (User and Supervisor code respectively).

Default access codes – When a new configuration is created, MaxCon Software fills in two default access codes - one giving access to a User level, and the other giving access to a Supervisor level:-

- 0000 – User code
- 9999 – Supervisor code

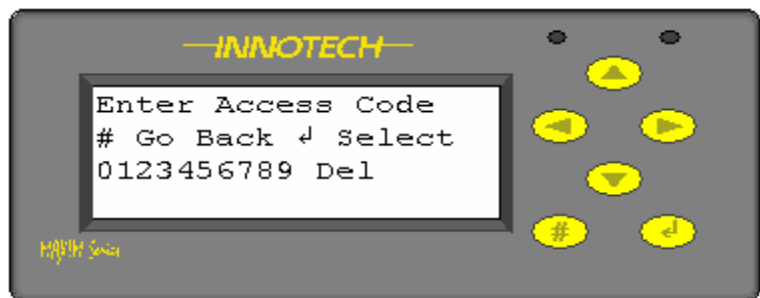

Figure 10 : Access Codes (1)

If the codes are not known, upload the program using the MaxCon software and they can be obtained from the *Config|Access Codes* menu option. Also, remember that access codes are disabled by default.

To enter the access codes, press any key when the Home Page is displayed and the access code screen is then displayed, above right.

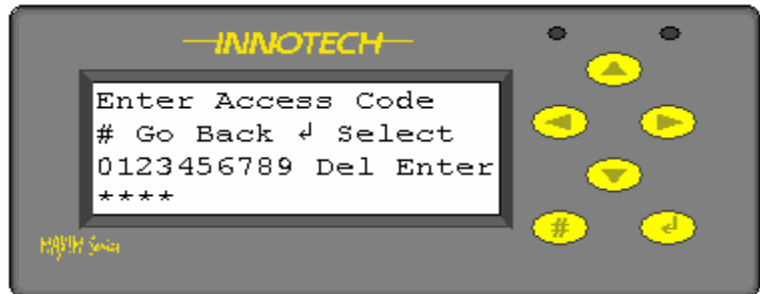

Figure 11 : Access Codes (2)







Use the  or  button to select the 4 digit code and as each number is highlighted press . An asterisk appears on the bottom line for each number entered. When all four numbers are entered correctly, press  again. If an incorrect code is entered, the display shows *Invalid Code* and time out after 5 seconds, returning to the Home Page.









Figure 12 : Access Codes (3)

If the correct code is entered, the display changes to the Navigate Screen. To change a code during entry highlight *Del*, and press  and the last number entered is removed. Press  again and the next number is removed and so on.

2-6 Navigation Page



Figure 13 : Navigate Menu

In this display the "Status" is flashing, this can be selected via  or another option can be selected by using , , ,  keys to move the cursor to the required position and then pressing .

During the session once logged ON, pressing the  button displays the "Navigate" screen allowing the operator to select the next function. Where lines 1 and 2 of the display provide advice on the key function. This is the starting point for the menu tree Figure 5 shown in section 2.2 and is the default screen when entering Supervisor Mode, explained in Section 3.0.

2-7 Status Menu

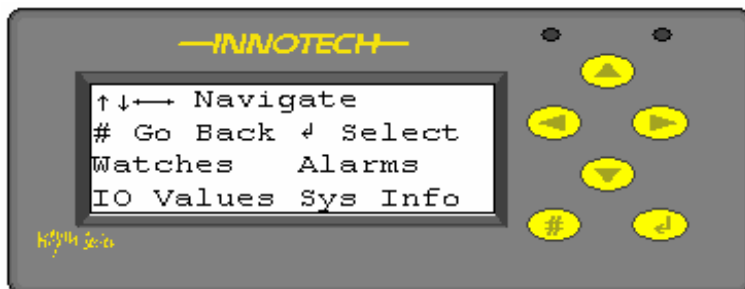









Figure 14 : Status Menu

Pressing  accesses the *Status* page of the controller and allows the user to scroll through the menu tree. In this display *Watches* is flashing. Select this via  or choose another option using , , ,  buttons and press .

2-7-1 Status Menu – Watches



One of the features of the Maxim Series Digital Controller is the ability to display pages of information which can be accessed via the “Watches” option. Each page typically contains data to be monitored by the user (hence the term Watch Page) and process values, such as a controller setpoint, which may be viewed and edited.





Figure 15 : Typical Watch Page

The content of each page is normally arranged in a logical manner. For example, all the data on Watch Page 3 might represent parameters for Heating Zone 3 and the name of the particular Watch Page can be configured. So for the above example instead of -> *Page 1 ! Watch 1*, the page could be named *CHW Pumps*.

The arrangement and content of each Watch Page is programmed by the MaxCon configuration software. For that reason Watch Pages are unique to the controller for which they were configured. Representations of Watch Pages shown in this manual are typical examples only.

The controller Watches are accessed from the Home Page by pressing , select the Status option and press  again. This accesses the Status menu. Pressing  again accesses the Watch pages.

Above is an example of a typical Watch Page displayed at the LCD screen. A Watch occupies lines 3 & 4 of the page. In this sample page the **CHW Pump 1 Status** Watch is a monitored value or condition which cannot be edited by the user.

Using  button, the operator can move to the other Watch Pages, the designation of each page being shown in the top left hand corner of the screen. When the correct page has been reached, the  or  buttons allow the operator to move between the Watch's on that page.

The **LCHW Temp Setpoint** Watch to the right is a process value that can be edited by the user. This value can be edited through the use of front panel controls. Watches that can be edited by the operator are identified by the extra command that appears on the 2nd line, '↵ Edit'.

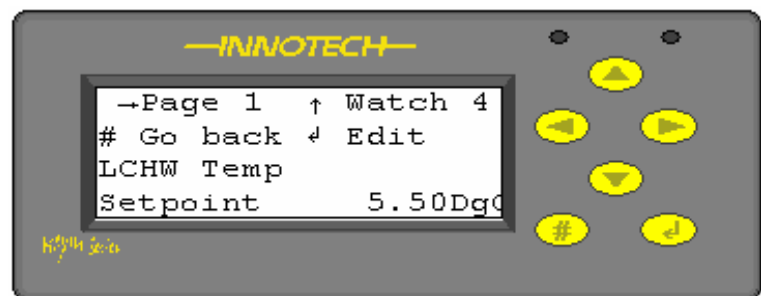

Figure 16 : Typical Adjustable Watch Value

The maximum numbers of Pages/Watches that can be displayed on a controller are:-

- 5 Pages and 5 x Watches/Page : MiniMax, Maxim I and II Controllers
- 8 Pages and 10 x Watches/Page : Maxim III Controllers

2-7-2 Status Menu – Alarms

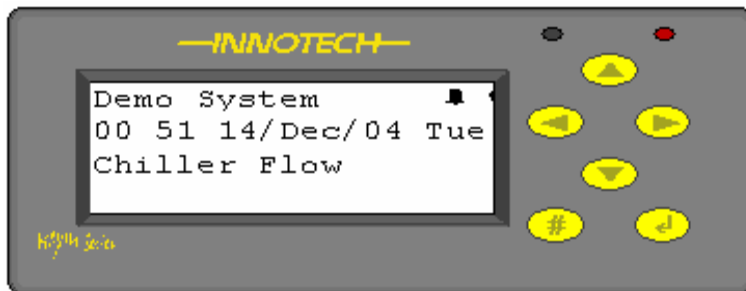

Figure 17 : Typical Flash Page Alarm

Alarms can be included in the application program and, depending how these have been configured, when activated, will either appear constantly on the display or if other alarms are present are rotated every 5 seconds. The maximum number of alarms that can be placed in a configuration is:-

- MiniMax – 16 per device
- Maxim I / II – 16 per device
- Maxim III – 32 per device

On the Flash Page the presence of an alarm is indicated by the Alarm LED flashing and an Alarm symbol appearing in the top right hand corner of the display. The alarm message, configured in the alarm block, is shown on the 3rd and 4th line of the display.

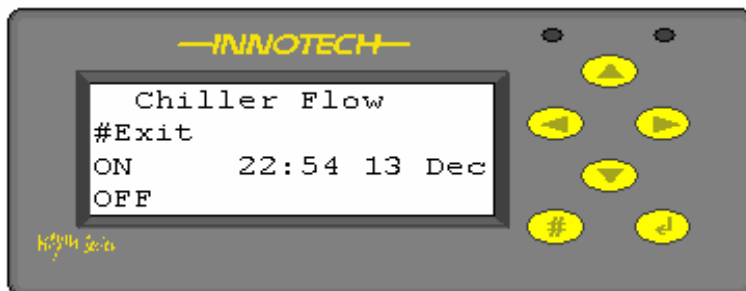

Figure 18 : Typical Alarm Page

Alternatively, using the specific Alarms page, found under the menu option *Status/Alarms*, the active alarms can be displayed as shown right. Line 1 shows the *Alarm Message*, Line 2 is the *Key commands* associated with the page, Lines 3 & 4 display the time/date the alarm was started and stopped.

2-7-3 Status Menu – IO Values

The IO Values screen can be used to display the values directly at the inputs and outputs of the controller. It is not necessary to have an application program downloaded to view these values.

The first page displayed is Universal inputs used to display the values directly at the inputs and outputs of the controller.

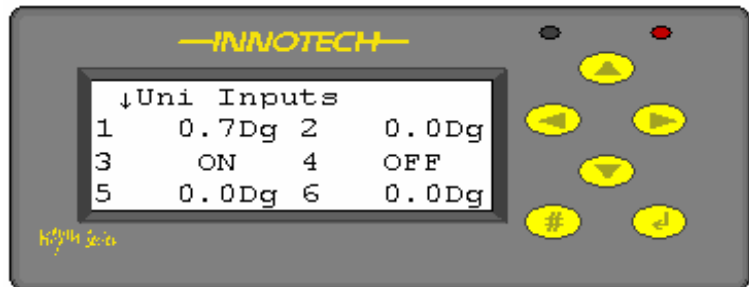





Figure 19 : Universal Inputs Page

Use  to view the other two pages and  to return to the previous menu. It is not necessary to have an application program downloaded to view these values. The first page to be displayed is the Universal inputs, use  to view the other two pages and  to return to the previous menu.

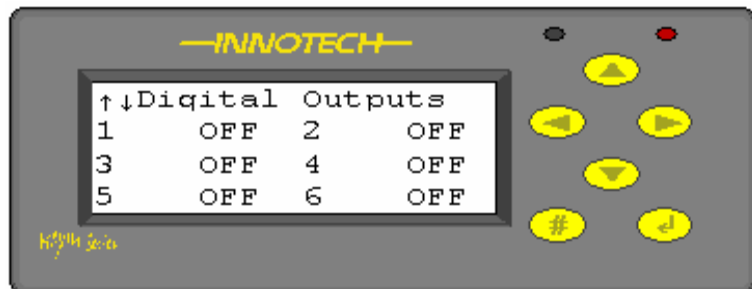

Figure 20 : Digital Outputs Page

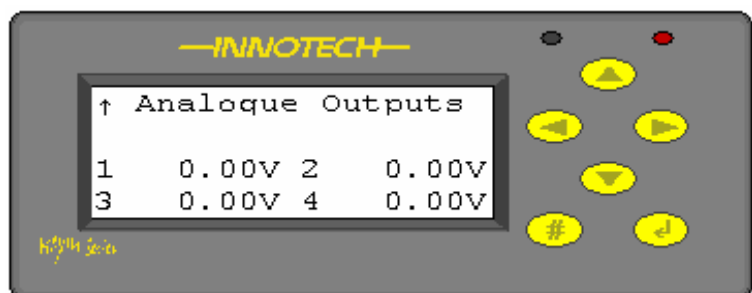

Figure 21 : Analogue Outputs Page

2-7-4 Status Menu – System Info

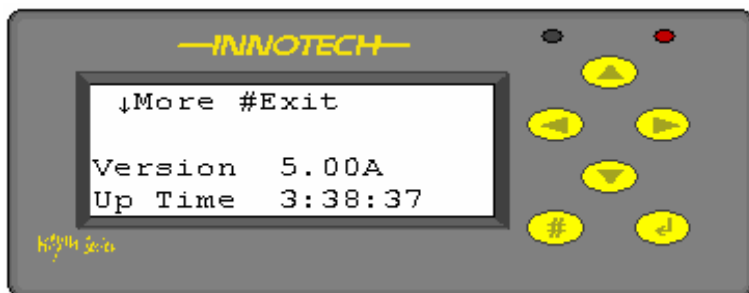



Figure 22 : System Information (1)

Use  and  buttons to move between the displays and return to the previous display as required.

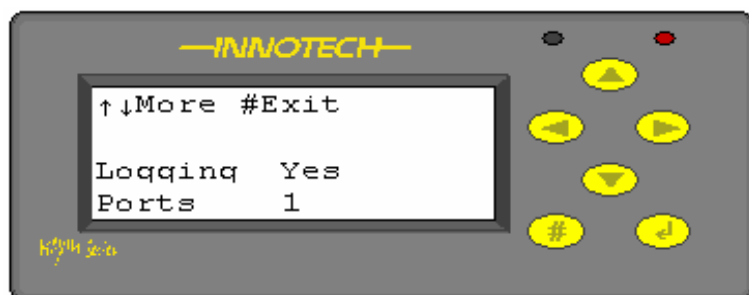

Figure 23 : System Information (2)

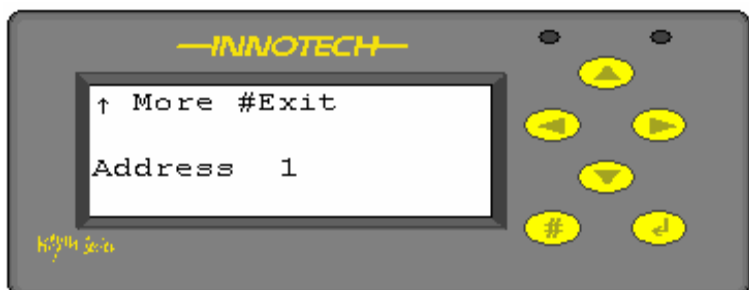

Figure 24 : System Information (3)

The *Sys Info* screens display information about the controller and are useful in terms of diagnostics to find out what type of controller it is, what firmware version is fitted and so on.







Screen 1 displays the firmware version and the time the controller has been running since the last power cycle.

Screen 2 shows whether the device is capable of performing data logging or not and also displays the number of communications ports. In this particular case the controller has logging capability but only one port; if a display is fitted it would be a Maxim *MAXILD* type.

Screen 3 shows the Network address of the device. In the case of the Maxim I device this is always "1".

If a Maxim II or III device is being used this could be between 1 and 128.

2-8 Clock – General

From the Home Page, press  button to enter the Navigate screen. Use , , ,  buttons to select the *Clock* menu option which should be flashing and then press  again. The Set Clock option is now flashing.

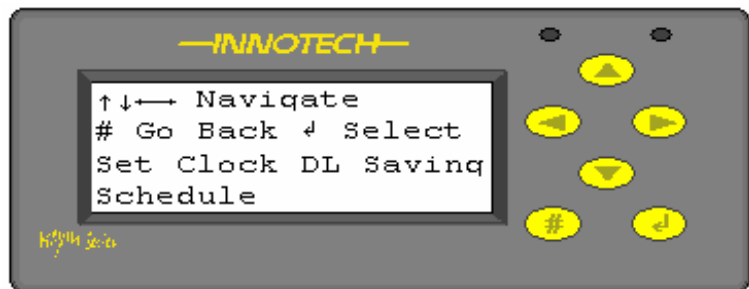



Figure 25 : Clock Menu

Three menu options are now displayed:-

- Set Clock – allows the operator to reset the current Time/Date
- DL Saving – allows the operator to reset the Summer/Winter start and stop times
- Schedule – allows the operator to adjust the *Weekly* or *Yearly* plant Schedules

Use the arrow keys to select the required option which then flashes. Now press 

✓ Notes:

Controllers are set (ex.factory) to Australian time and may be 9 hours ahead of UK time. It is important to reset the clock as soon as practical.

MiniMax - schedule blocks can be incorporated into a MiniMax application but the controller does not have an internal RTC chip. It relies on getting a time synch pulse from the network master (a Maxim II or III device at address 1) to reset the MiniMax internal counter. The synch pulse is sent both when the device at address 1 is powered up and at 3.00am. It is also requested when a Minimax powers up. The counter will only be reset if it differs by more than 60 seconds from the synchronised time.

2-8-1 Clock – Set Clock

Select the Set Clock option to display System Time, right. Use steps 1-6 below to adjust Time/Date settings.









1. Press  to display the time/date change screen as shown above.
2. Press  again and the "Hrs:" starts flashing.



Figure 26 : System Time/Date

3. Press  or  buttons to select the value to edit. The flashing text indicates what has been selected to edit.
4. Then use ,  to change the value.
5. Repeat steps 1-4 for the rest of the displayed values until the correct Time / Date is displayed.
6. Press  to save or  to abort the changes.
7. Finally, press  several times until the Home Page is displayed.

2-8-2 Clock – DL Saving Start/Stop



Figure 27 : DL Saving Status

After selecting the DL Saving option the DL Saving Status display, left, is shown. Use the steps 1-6 below to adjust the Start Time.

Use the or buttons to select either the Status, Start or Stop screens depending on the action required.



Figure 28 : DL Saving Start

The Daylight Saving Start operation is determined by specifying the occurrence, *First, Second, Third, Fourth or Last*; the Day of the week, *Mon – Sun*, and the Month, *Jan - Dec*

When this has been specified, the program will calculate the date of the next event which changes annually.

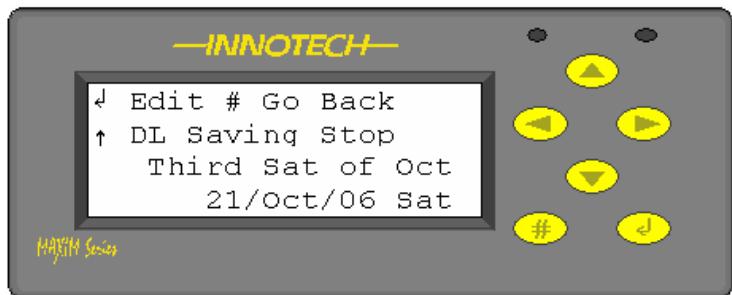

Figure 29 : DL Saving Stop

The Daylight Saving Stop operation is determined in the same manner as the Start operation

When this has been specified, the program will calculate the date of the next event which changes annually.

1. Press and *Enabled* starts flashing. Press or buttons to select the required status, press to accept.
2. Press or buttons to change to the DL Saving Start display.
3. Press and *occurrence* starts flashing. Use or buttons to select.
4. Press or buttons to move to *Day* and use or buttons to select.
5. Press or buttons to move to *Month* and use or buttons to select.
6. Press and the DL Saving Start date will be calculated automatically.
7. Use or buttons to change to the DL Saving Stop menu and repeat steps 3-6
8. Finally, press several times until the Home Page is displayed.

✓ **Note:** The default Daylight saving time is a Universal Time offset of 1 hour and cannot be changed.

2-8-3 Clock – Schedule

After selecting the Schedule option the Schedule Edit display, right, is shown. Use the steps shown to the right to adjust the required schedules. Users should note that although the switch times within a schedule block can be added to, edited or deleted through the keypad and display, the actual schedule itself cannot be deleted from or new ones added, to the program.



Figure 30 : Schedule Edit

The application program can have three types of Schedules programmed:-

- The Daily Schedule block performs the function of a daily time clock. Over a one day time period, you are able to specify up to 8 START/STOP pairs with a resolution down to a minute, this is then repeated every day.
- The Weekly Schedule block performs the function of a seven day time clock. Over a seven day time period, you are able to specify up to either 16 or 32 START/STOP pairs (depending on the primary device selected) with a resolution down to a minute. The maximum number of START/STOP pairs allowed on the Maxim I and II Controllers is 16 and on the Maxim III Controller is 32.
- The Exception Schedule block (referred to as *Yearly* on Maxim displays) provides an override function for system control. The schedule can contain up to the maximum number of time periods allowed (depending on the primary device selected) individual time periods setting an output value state to ON or OFF over a 365 day period (366 in leap years). The maximum number of time periods allowed on the Maxim I and II Controllers is 16 and on the Maxim III Controller is 32. The exception schedule itself may be overridden with an input, so that you can chain together multiple exception schedules as necessary.

2-8-3-1 Clock – Schedule – Daily – Add



Figure 31 : Daily Add/Edit/Del

Selecting the Daily, Weekly or Yearly options allows the operator to **Add**, **Edit** or **Delete** an existing schedule times and/or dates. A typical screen display is shown left.

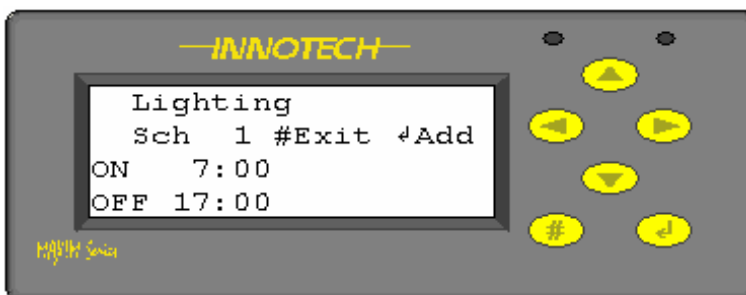





Figure 32 : Daily Schedule Add (1)

Select the *Daily/Add Daily* menu option and press  and the Daily Schedule Add screen is displayed.

Use  or  buttons to select the schedule to which a new switch time is to be added.

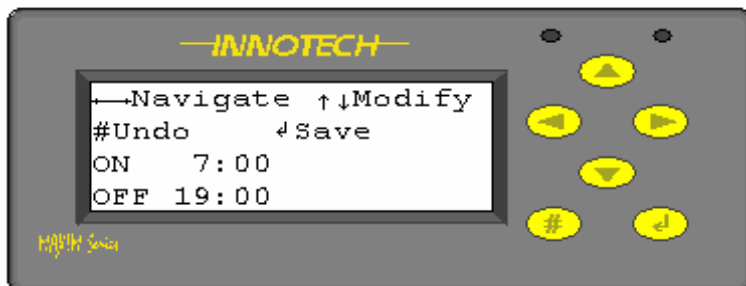











Figure 33 : Daily Schedule Add (2)

Press  again and the ON time begins to flash.

Following the instructions below to Add a new switch time to the Daily schedule block.

1. Press  again and the ON time begins to flash.
2. Use  or  buttons to change the time.
3. Use  or  buttons to select the *ON* or *OFF* times and the respective *hours* or *minutes* to be changed.
4. At each point the selected value flashes.
5. Once the correct time has been set up, press  to save or  to undo the changes.

The new switch times will not be displayed in this screen area. To check if the times have been set correctly return to the Daily/Edit menu option and scroll through the switch times with the  and  buttons.



2-8-3-2 Clock – Schedule – Daily – Edit

Selecting the Daily, Weekly or Yearly options allows the operator to **Add**, **Edit** or **Delete** an existing schedule times and/or dates. A typical screen display is shown right.



Figure 34 : Daily Add/Edit/Del

Select the *Daily/Edit Daily* menu option and press  and the Daily Schedule Edit screen is displayed, right.

Use the  or  buttons to select the Schedule that has the switch times to be changed.

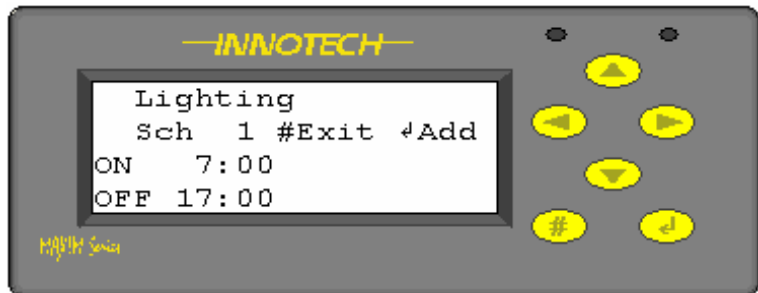



Figure 35 : Daily Schedule Edit (1)

Press  again and the ON time begins to flash, right.

Following the instructions below to Edit an existing switch time in the *Daily* schedule block.

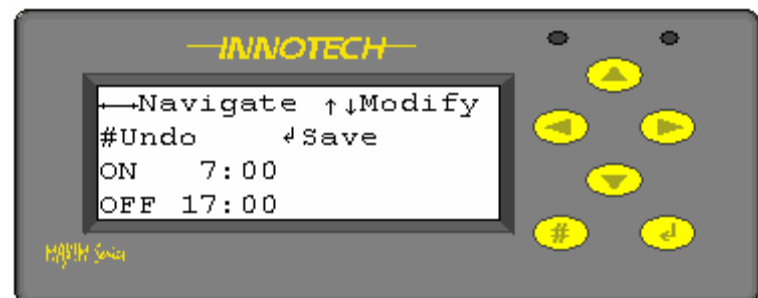









Figure 36 : Daily Schedule Edit (2)

1. Press  again and the ON time begins to flash.
2. Use  or  buttons to change the time.
3. Use  or  buttons to select the *ON* or *OFF* times and the respective *hours* or *minutes* to be changed.
4. At each point the selected value is flash.
5. Once the correct time has been set up, press  to save or  to abort the changes.

2-8-3-3 Clock – Schedule – Daily – Delete



Selecting the Daily, Weekly or Yearly options allows the operator to **Add**, **Edit** or **Delete** an existing schedule times and/or dates. A typical screen display is shown left.



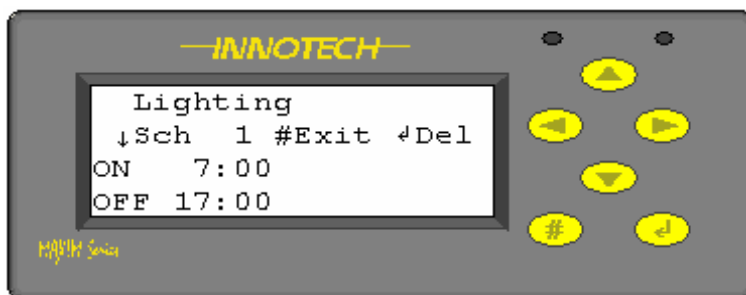



Figure 37 : Daily Add/Edit/Del



Select the *Del Daily* menu option and press , the Daily Schedule *Del* screen is displayed, left.

Follow the instructions below to delete an existing switch time in the Daily schedule block.

Figure 38 : Daily Schedule Delete

1. Use the  or  buttons to select the Schedule to edit.
2. Use  or  buttons to select the switch time to delete.
3. Press  to delete the selected time.
4. Press  to return to the previous menu.

✓ **Note:** There is no “undo” function. If a switch time is deleted by mistake it is have to be re-entered using the “ADD” function.

2-8-3-4 Clock – Schedule – Weekly – Add

Selecting the Daily, Weekly or Yearly options allows the operator to **Add**, **Edit** or **Delete** an existing schedule times and/or dates. A typical screen display is shown right.



Figure 39 : Weekly Schedule

Select the *Add Wkly* menu option and press and the Weekly Schedule Add screen is displayed.

Use or buttons to select the schedule which has the switch times to be changed.

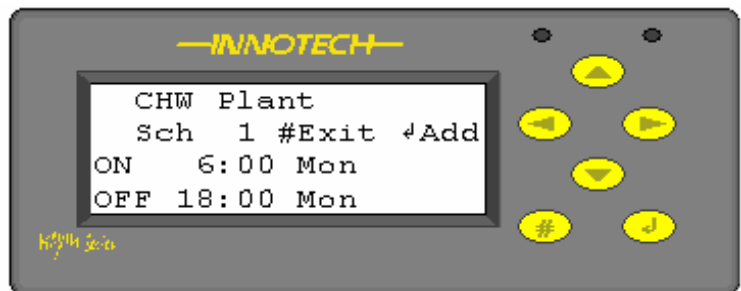

Figure 40 : Add Weekly Schedule (1)

Press again and the ON time begins to flash.

Follow the instructions below to Add a new switch time to the Weekly schedule block.

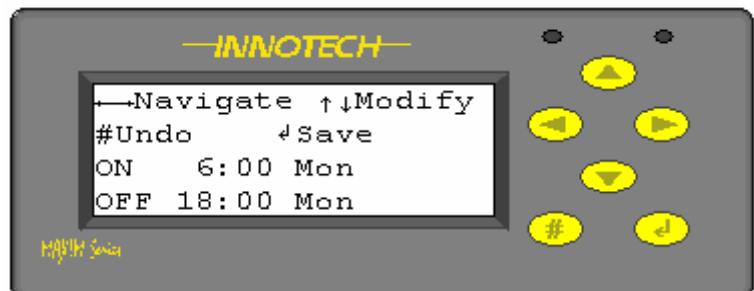

Figure 41 : Add Weekly Schedule (2)

1. Press again and the ON time begins to flash.
 2. Use or buttons to change the time.
 3. Use or buttons to select the *ON* or *OFF* times and the respective *hours* or *minutes* to be changed.
 4. At each point the selected value will flash.
 5. Once the correct time has been set up, press to save or to abort the changes.
- Once a new weekly event has been added and saved it can no longer be edited in this menu.

✓ **Note:** Press to move up a menu level and select the *Edit Wkly* menu option. Also be aware the 7 day clock starts on Sunday morning (00:00) and finishes on Saturday night (00:00).

2-8-3-5 Clock – Schedule – Weekly – Edit



Figure 42 : Weekly Schedule

Selecting the Daily, Weekly or Yearly options allows the operator to **Add**, **Edit** or **Delete** an existing schedule times and/or dates. A typical screen display is shown left.

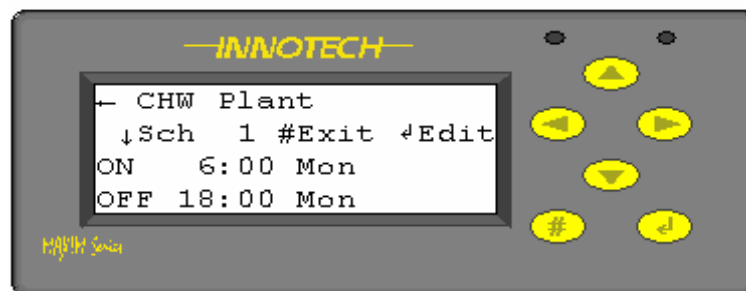





Figure 43 : Weekly Schedule Edit (1)

Select the *Wkly / Edit Wkly* menu option and press  and the Weekly Schedule Edit screen is displayed.

Use the  or  buttons to select the Schedule to edit.

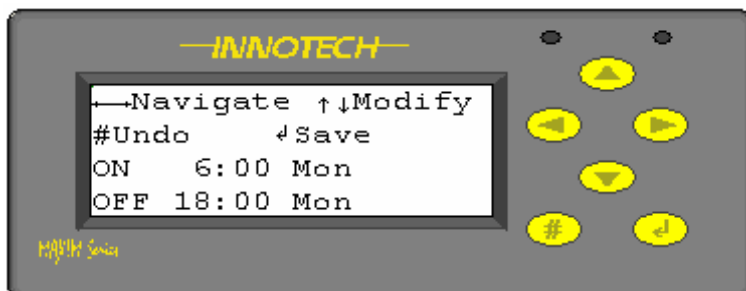









Figure 44 : Weekly Schedule Edit (2)

Press  again and the ON time begins to flash.

Following the instructions below to Edit an existing switch time in the *Wkly* schedule block.

1. Press  again and the ON time begins to flash.
2. Use  or  buttons to change the time.
3. Use  or  buttons to select the *ON* or *OFF* times and the respective *hours*, *minutes* or *Day* to be changed.
4. At each point the selected value will flash.
5. Once the correct time has been set up, press  to save or  to abort the changes.

2-8-3-6 Clock – Schedule – Weekly – Edit – 24hr Operation

Navigate to the Schedule/Weekly/Edit screen displayed left and then follow the instructions given below.

To change a schedule to enable a plant 24hrs a day follow the steps outlined below.

Select the *Wkly / Edit Wkly* menu option and press  and the Weekly Schedule Edit screen is displayed on the right.

Press  again and the ON time begins to flash, right.











Following the instructions below to Edit an existing switch time in the *Wkly* schedule block, the example given is for 24hr operation on a Sunday.



Figure 45 : Weekly Schedule (24hr)



Figure 46 : Weekly Schedule Edit (24hr Operation)

1. Press , the "ON" hrs should flash, then press  and change the time to "00:00".
2. Press , the "Day" should flash, then press  or  to change it to "Sun".
3. Press , the "OFF" hrs should flash, press  and change the time to "00:00".
4. Press , the "Day" should flash, press  or  to change it to "Mon".
5. Press  to save. The display should be as shown below.

✓ **Note:** It is important to realise the 7 day clock starts 00:00 Sunday morning and finishes 00:00 Saturday night. So the direction in which the time is adjusted is important. So make sure the instructions listed above are followed.

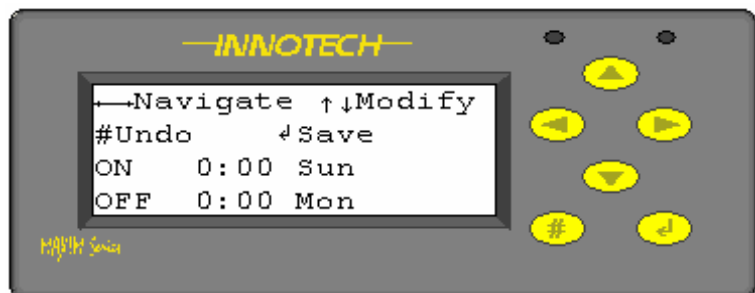

Figure 47 : Weekly Schedule Edit (24hr)

2-8-3-7 Clock – Schedule – Weekly – Delete

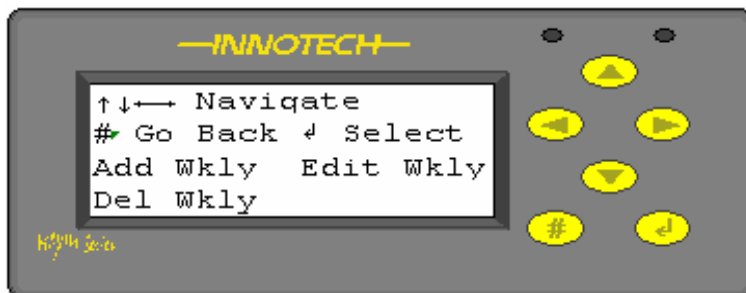

Figure 48 : Weekly Schedule

Selecting the Daily, Weekly or Yearly options allows the operator to **Add**, **Edit** or **Delete** an existing schedule times and/or dates. A typical screen display is shown left.

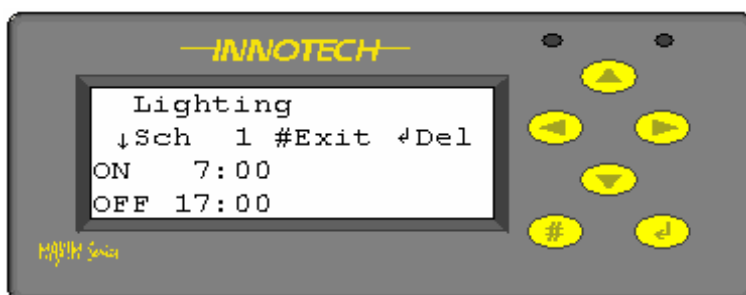











Figure 49 : Weekly Schedule Delete

Select the *Wkly / Del Wkly* menu option and press  and the Weekly Schedule Delete screen is as displayed on left.

Use the  or  buttons to select the Schedule to edit and follow the instructions below.

1. Use the  or  buttons to select the Schedule to edit.
2. Use  or  buttons to select the switch time to delete.
3. Press  to delete the selected time.
4. Press  to return to the previous menu.



Note: There is no “undo” function. If a switch time is deleted by mistake it will have to be re-entered using the “ADD” function.

2-8-3-8 Clock – Schedule – Yearly – Add

Selecting the Daily, Weekly or Yearly options allows the operator to **Add**, **Edit** or **Delete** an existing schedule times and/or dates. A typical screen display is shown right.



Figure 50 : Yearly Schedule

Select the *Add Yrly* menu option and press  and the Yearly Schedule Add screen is displayed, right.

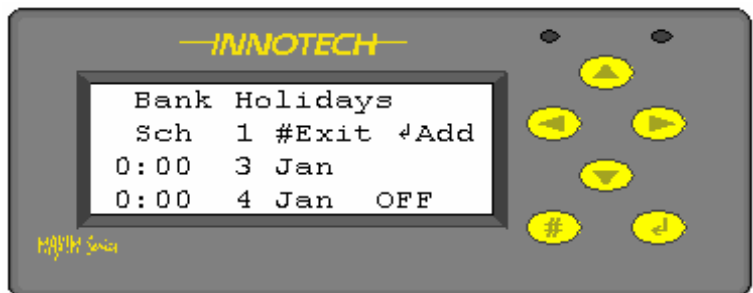



Figure 51 : Add Yearly Schedule (1)

Press  again and the display will change to show the current time/date as the new start/stop times, right. The *Hrs* on line 3 starts flashing.

Follow the instructions below to Add a new switch time to the Yearly schedule block.

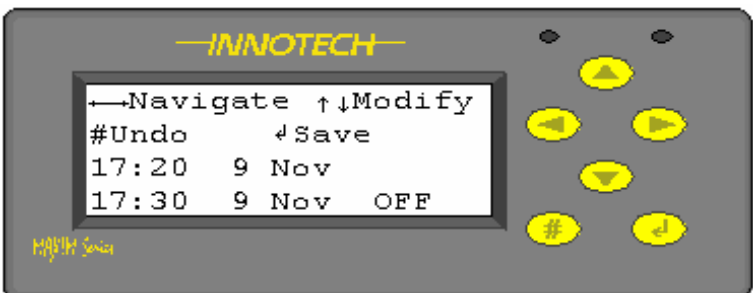









Figure 52 : Add Yearly Schedule (2)

1. Use  or  buttons to change the time/date.
2. Line 3 represents the time/date the schedule will start.
3. Line 4 represents the time/date will stop and also the override condition, in the case above, OFF.
4. Use  or  buttons to select the respective *hours, minutes, day, month, override condition* to be changed.
5. At each point the selected value will flash.
6. Once the correct values have been set up, press  to save or  to abort the changes.

✓ **Note:** These operations are relative to an existing Yearly schedule and cannot be used to add a new schedule block to the program. Also, once a new exception event has been added and saved it can no longer be edited in this menu.

Press  to move up a menu level and select the *Edit Yrly* menu option.

2-8-3-9 Clock – Schedule – Yearly – Edit



Figure 53 : Yearly Schedule

Selecting the Daily, Weekly or Yearly options allows the operator to **Add**, **Edit** or **Delete** an existing schedule times and/or dates. A typical screen display is shown left.

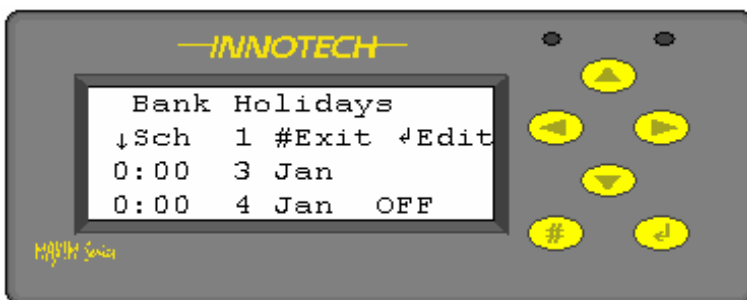





Figure 54 : Yearly Schedule Edit (1)

Select the *Edit Yrly* menu option and press  and the Yearly Schedule Edit screen is displayed, left.

Use the  or  buttons to select the Schedule to *Edit*.

Use  or  buttons to select the switch time to *Edit*.

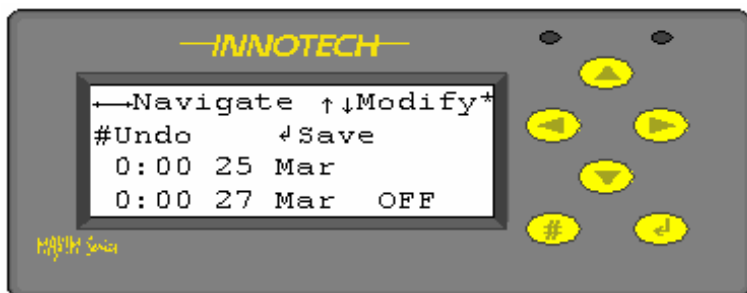







Figure 55 : Yearly Schedule Edit (2)

Following the instructions below to *Edit* an existing switch time in the *Yrly* schedule block.

1. Use  or  buttons to change the time.
2. Use  or  buttons to select the respective *hours, minutes, day, month, override condition* to be changed.
3. At each point the selected value will flash.
4. Once the correct time has been set up, press  to save or  to abort the changes.



2-8-3-10 Clock – Schedule – Yearly Delete

Selecting the Daily, Weekly or Yearly options allows the operator to **Add**, **Edit** or **Delete** an existing schedule times and/or dates. A typical screen display is shown right.



Figure 56 : Yearly Schedule

Select the *Yrly / Del Yrly* menu option and press  and the Yearly Schedule Delete screen is displayed, right.

Use the  or  buttons to select the Schedule to edit and follow the instructions below.

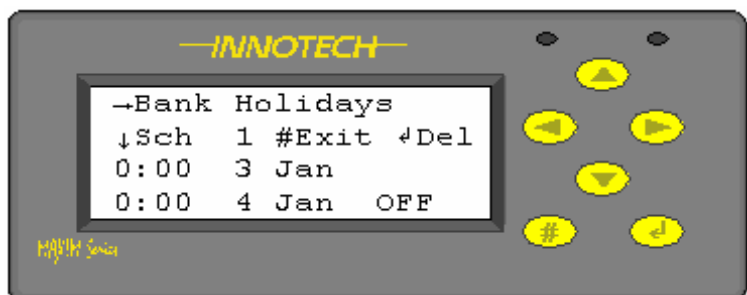







Figure 57 : Yearly Schedule Delete

1. Use the  or  buttons to select the Schedule to edit.
2. Use  or  buttons to select the switch time to delete.
3. Press  to delete the selected time.
4. Press  to return to the previous menu.

✓ **Note:** There is no “undo” function. If a switch time is deleted by mistake it will have to be re-entered using the “ADD” function.

2-9 Setup – General

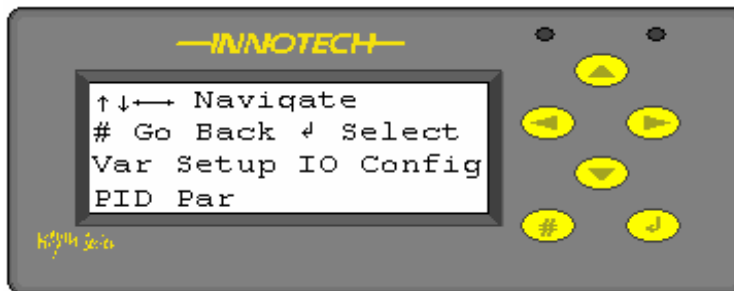

Figure 58 : Setup Menu

From the Home Page

press button to display the "Navigate" screen, press and to display the Setup menu.

In this operating mode the setup can only be viewed and not in any way amended.

In this display *Var Setup* is flashing.

Select this via or choose another option using , , , buttons and press .

2-9-1 Setup – VAR Setup



Figure 59 : Variable Setup (1)

This series of screen displays allows the user to page through the *Watches* that have been configured for the controller.

Watches that are configured as status points or measured values cannot be changed and the *Edit* command, (bottom left) is set to "N".

However, *watches* such as analogue or digital setpoints can have their *Edit* command set to "Y" as in the case below, or "N".



Figure 60 : Variable Setup (2)

If EDIT = "Y", it allows the user to change the value from the keypad from within the *Status/Watches* display at the normal user or default access level.

If EDIT = "N", the user cannot change the value unless they logon to the controller in Supervisor Mode from the *Home* Page.

This is a simple way of preventing unauthorised access to key setpoints and other variable parameters.



Note: The value of the Edit command can only be adjusted in Supervisor Mode.

2-9-2 Setup – IO Config

This series of screen displays show the user the following information. The information displayed is read only.

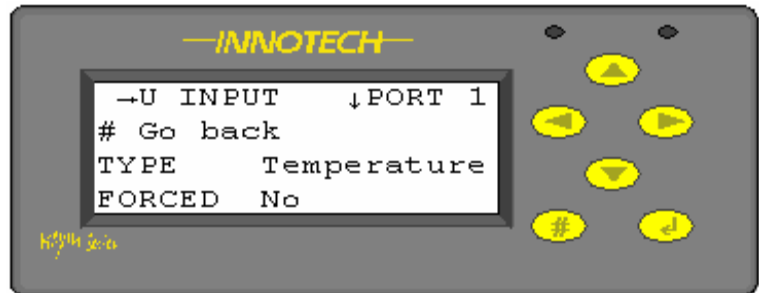

Figure 61 : IO Config Display (1)

Line 1 – defines the input type and the terminal number, in the above case, Universal Input #1.

Line 2 – is a menu command and allows the user to return to the previous page.

Line 3 – defines the input type, in this case a measured value, Temperature.

Line 4 – defines whether the output has been *forced* (ie. manually overridden).

The screen display right, shows the same Universal Input, but this time the value has been overridden, so the command Forced = "Y".

The figure, right, is the value that the input has been "forced" to, in this case, 5.2degC.

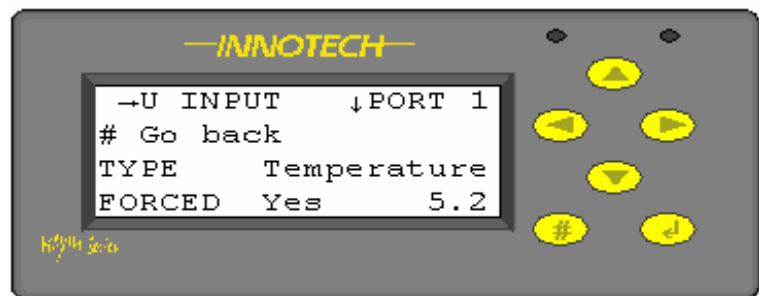

Figure 62 : IO Config Display (2)

A typical analogue output which has been forced or manually overridden is shown right. The output is a 0-10V analogue signal on AO#1.

In this case it has been forced or overridden to 6.0V.

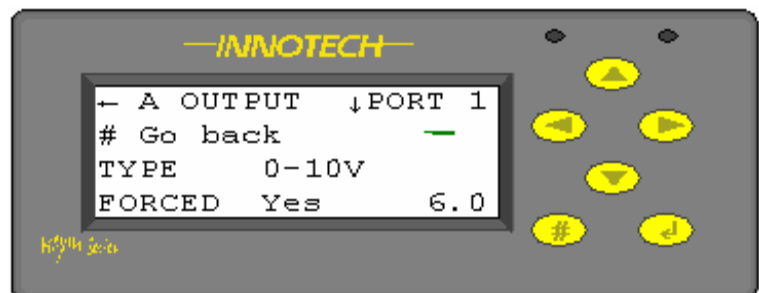

Figure 63 : IO Config Display (3)



Note: As mentioned earlier these screens are read-only and are accessible at the default user level. For access to modify the values, change or cancel forced inputs and outputs back to automatic control etc, the user will need to have the correct access level and logon to the Supervisor Mode.

2-9-3 Setup – PID PAR

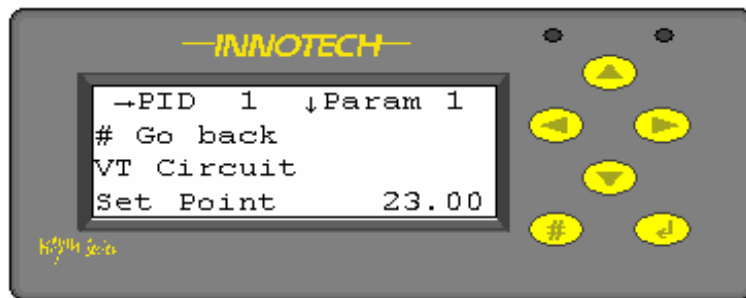

Figure 64 : PID Parameter



This series of screen displays show the user the internal block values for any PID control loops used within the software configuration of the controller. The information displayed is read only.

The PID Loop block is a twin output proportional plus integral and derivative control loop. It is one of the primary control blocks used for maintaining constant temperature, humidity or controlled variable.

Line 1 – defines the PID block number, in the above case we are looking at PID Loop #1







Line 2 – is a menu command and allows the user to return to the previous page

Line 3 – defines the block name, in this case *VT Circuit*.

Line 4 – defines the internal setpoint, *23.00*. Use the ,  buttons to display the other internal block values and settings, these are listed below:-

- *Setpoint* – This is the setpoint of the PID Loop to which the input to the block should finally settle, which is used only if the **SETPOINT** input to the block is not connected to a **User Variable**. This does not have to be connected, but doing so allows the setpoint to be modified (via an Editable Watch on a User Variable) during Maxim operation.
- *Dead Band* – This is the total range of the Dead Band for the PID Loop. This is the range of values (centred about the Setpoint) in which no Direct or Reverse acting control is used.
- *Alpha* – This is a smoothing constant (percentage) used in the integral and derivative calculations for the block. It is a representation of how fast the output value will change to meet the required value. An alpha of 100% will change immediately to the required value, whereas an alpha of 50% will only move half way toward the required value each time the block is processed. Note: If Alpha is set to 0% the block behaves the same as if it was set to 100% (otherwise the block output value would never change).
- *Direct P* (also *Direct I* and *Direct D*) – This group of fields provides for the setting of the Proportional Band range for the PID control loop as well as fine tuning of the derivative and integral constants for the calculation for the direct acting part of the PID Loop.
- *Reverse P* (also *Reverse I* and *Reverse D*) – This group of fields provides for the setting of the Proportional Band range for the PID control loop as well as fine tuning of the derivative and integral constants for the calculation for the reverse acting part of the PID Loop.

2-10 Commission

From the Home Page press the  button to display the "Navigate" screen. Use the , , ,  buttons to select the *Commission* function and then press  again. The information displayed is read only.

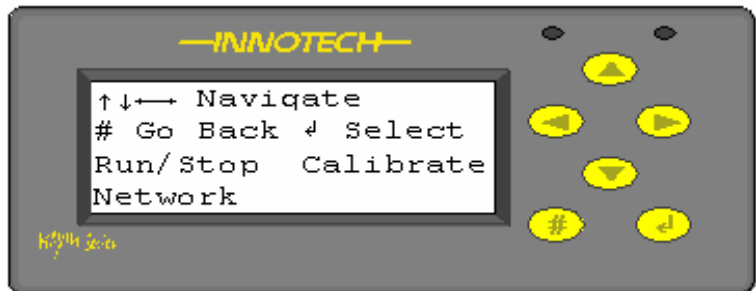

Figure 65 : Commission Menu Display

2-10-1 Commission – Run/Stop

The *Run/Stop* function allows the controller processor to be stopped and started as required. When in the *Stopped* mode processing is suspended and the controller is effectively switched off (ie. analogue outputs would be *0V*, digital outputs would be *Off*). The state can only be changed in the Supervisor mode of operation.



Figure 66 : Run/Stop Menu Display

This function is extremely useful. It allows a controller to be pre-programmed prior to despatch but putting it into the *Stopped* mode allows it to be powered on site in a safe state. Once all the commissioning checks have been carried out and the user is satisfied all external devices have been correctly connected and configured, changing the state to Running then allows the application program to run.

2-10-2 Commission – Calibrate

The *Calibrate* function allows the user to view the analogue inputs and see if the signal has been adjusted to take into account any variance in cable resistance or sensor calibration.

Press the ,  buttons to page through the inputs.

The calibration can only be changed in the Supervisor mode of operation.

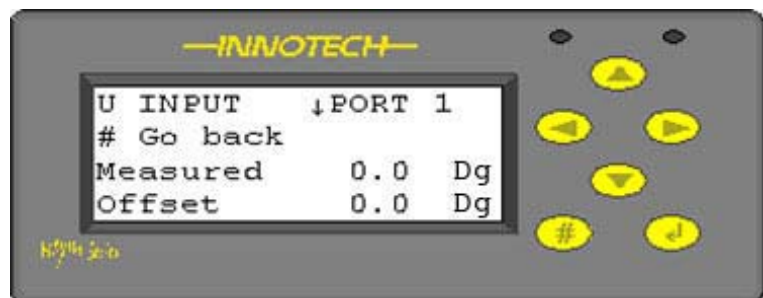

Figure 67 : Calibrate Menu Display

2-10-3 Commission – Network

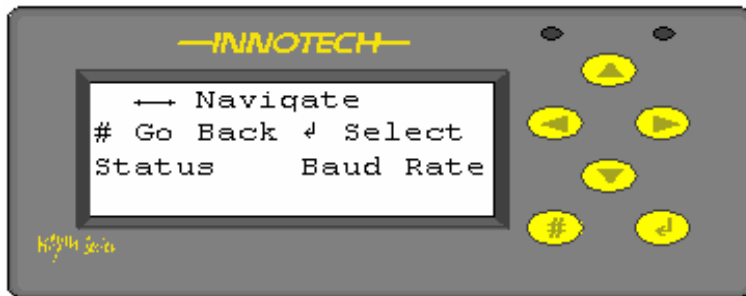



Figure 68 : Network Menu Display

From the *Commission* page select *Network* and press the  button to display the screen left. The information displayed is read only.

2-10-3-1 Commission – Network – Status

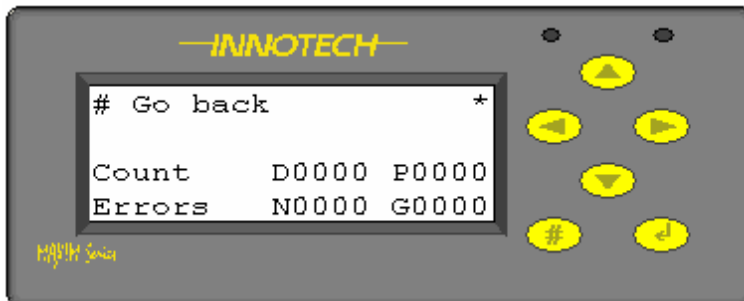



Figure 69 : Network Status Display

From the *Network* display menu select *Status* and press .

It is possible to test the controller network using the test function in the software packages (*Communicate - Comms Test*). The PC sends out messages to the device and part of the contents of the message tells it how many messages have been sent.

The "D0000" is the number of these network test messages the device has received, and the "P0000" is the number of messages that the PC says have been sent.

If a *Comms Test* is carried out and these numbers aren't the same (or very close) then some messages have gone astray, possibly because of a bad network. In all cases it is advisable to leave the test running for several minutes so as to obtain a significant sample.

The "G0000" and "N0000" are network errors for the Global and Net comms networks respectively. These are not related to the *Comms Test* described above (although a failure on the there would also show up in the network errors list).

These are "receive" errors only since the device doesn't check its own transmissions. The device determines that a network message has failed by looking at the header and the message checksums, however if the message is so badly corrupted that it doesn't even begin correctly, it won't appear as a bad message rather the device will just ignore it until it sees the start of a proper message.

2-10-3-2 Commission – Network – Baud

From the *Network* display menu select *Baud* and press 

This screen displays the speed at which the two networks, Global and Net, communicate.

Net Comms (*NET*) – provides a means to configure or monitor the Maxim Series Digital Controller from a PC at a speed of 9600 or 57600 baud.



Figure 70 : Network Baud Rate Display

A local PC can be connected to the Net Comms via:-

- A MPI modem and printer interface unit
- a GENII Converter USB – USB/RS485 converter
- A GENII Converter NT – RS232/RS485 Converter (for legacy systems)
- A building Ethernet network, using a Maxim III "E" versions or a suitable RS485/Ethernet converter for other Maxim types.

A PC with a modem at a remote location can access this network through the telephone system via a modem connected to an MPI or GENII Converter NT on the Net Comms. Caution must be exercised if a PC and an MPI or more than one PC is directly connected to the Net Comms. Only one can be active at any time otherwise a conflict between them causes data corruption.

However, using Innotech IComm server software, many computers can simultaneously communicate with a single network. Many users can communicate with the IComm server, but only one device can connect to a RS485 network.

Global Comms (*GBL*) – provides a means for control data to be shared between the Digital Controllers and a GENII MPI at a data speed of 4800 or 38400 baud. There is no facility to connect a PC to the Global Points network through a Digital Controller or GENII MPI. If it is necessary to monitor the Global Points traffic, a GENII CONVERTER can be used to connect to the Global Points Comms cable and use the Genesis Global Points Monitor software to view the data.

Section 3 – Supervisor Mode

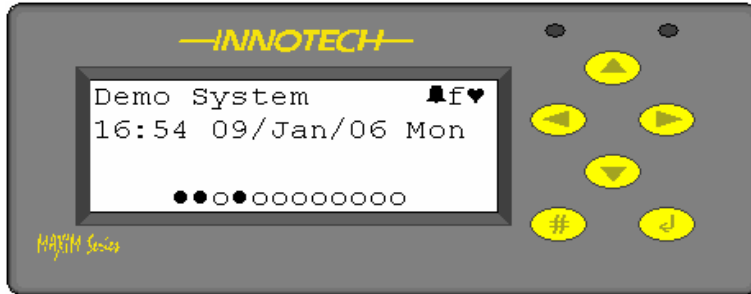

Figure 71 : Home Page Display

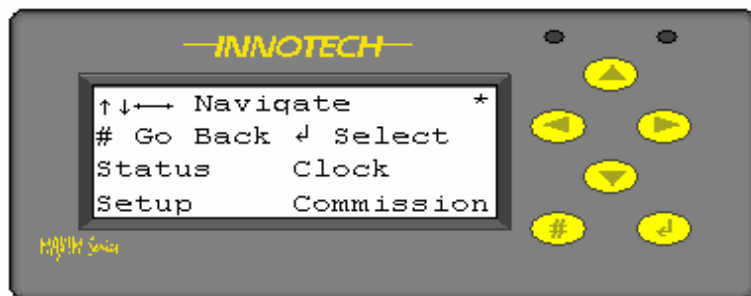



Figure 72 : Navigate Menu

This is a protected access feature that allows the operator a greater level of adjustment than that of a normal user.

From the *Home Page*, right, press  and  together and hold until the display changes to the *Navigate* menu, Figure 69. This takes about 5-6 seconds.

A "*" is shown in the top right hand corner of the display when in *Supervisor Mode*.

If no buttons are pressed within any 5min period, the display will revert to the *Home Page* and logout from the *Supervisor Mode* automatically.

Only certain commands are changed within this mode and they are explained in the following pages.

3-1 Access Codes

When the controller is configured it is possible to prevent unauthorised access to any of the functions using Access Codes. These can only be set from within the MaxCon software and are downloaded to the controller during commissioning. The default setting in the MaxCon software is OFF, which means that access codes are ignored.

If access codes are enabled, there are two options:–

- *Only Supervisor code required* – If this option is selected access is allowed to the User level without any restrictions but to get to the Supervisor level the user has to enter the appropriate access code (Supervisor code).
- *Both User and Supervisor codes required* – If this option is selected access to both User and Supervisor level is allowed only after the appropriate access codes are entered (User and Supervisor code respectively).

Default access codes – When a new configuration is created, the MaxCon software fills in two default access codes – one giving access to a User level, and the other giving access to a Supervisor level.

- 0000 – User code
- 9999 – Supervisor code

If the codes are not known, upload the program using the MaxCon software and they can be obtained from the *Config|Access Codes* menu option. Also, remember that access codes are disabled by default.



Figure 73 : Access Codes (1)

To enter the access codes, press any key when the Home Page is displayed and the access code screen are displayed, right.





Use the  or  button to select the 4 digit code and as each number is highlighted press .





Figure 74 : Access Codes (2)

An asterisk will appear on the bottom line for each number entered. When all four numbers are entered correctly, press  again. If an incorrect code is entered, the display is show *Invalid Code* and time out after 5 seconds, returning to the Home Page.

If the correct code is entered the display is change to the Navigate Screen.



Figure 75 : Access Codes (3)

To change a code during entry highlight *Del*, and press  and the last number entered is removed. Press  again and the next number is removed and so on.

3-2 Status – Watches

It is possible to “lock” setpoints (See section 3-3.1 for further information) so that they cannot be adjusted in the normal user level. However, in Supervisor Mode any setpoint values defined as Watches can be adjusted. For further information on *Watches* refer to Section 2 of this manual.

3-3 Setup – General

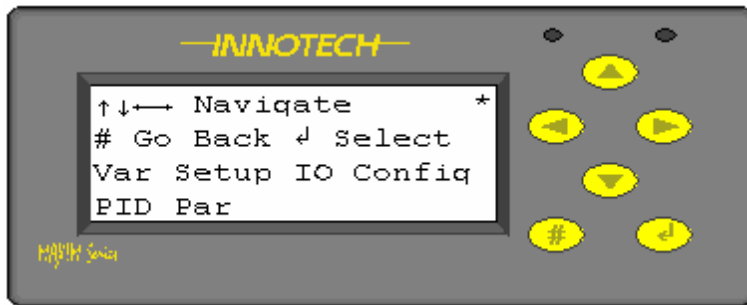

Figure 76 : Setup Menu (Supervisor Mode)

Press button to display the "Navigate" screen, press and to display the Setup menu. In this display *Var Setup* is flashing. Select this via or choose another option using , , , buttons and press .

3-3-1 Setup – VAR Setup (Locking Setpoints)



Figure 77 : VAR Setup

It is possible to "lock" setpoint Watches so they cannot be adjusted by casual users.

To do this, enter the *Var Setup* menu function and find the setpoint Watch you want to protect. A typical example is shown to the left.

- If *EDIT* = "Y", it allows the user to change the value from the keypad from within the *Status/Watches* display at the normal user or default access level.
- If *EDIT* = "N", the user cannot change the value unless they have access to *Supervisor* Mode.
- Press and the "Y" will flash. Use the , buttons to select the required characteristics (N = users cannot change the value, Y = allows users to change the value).
- Finally press to save the new setting.

✓ **Note:** this function only locks the adjustment from the keypad. The value can still be overridden via the *MaxMon* or *Magellan* software programs.

3-3-2 Setup – IO Config

This menu allows *Universal Inputs* or *Analogue / Digital Outputs* to be manually overridden by the operator.

Generally this is only done during the initial commissioning phase, but can be a useful tool during plant operation in the event of say, an outside air sensor failure causing a boiler shutdown.

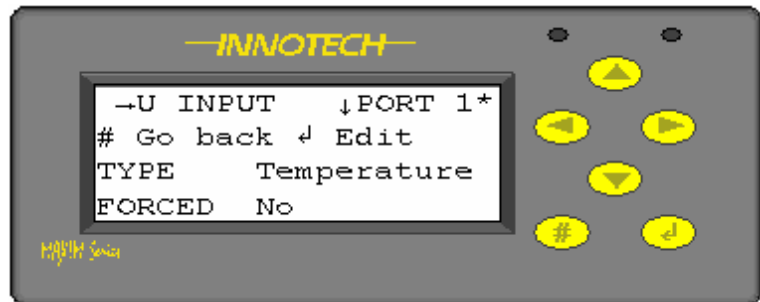

Figure 78 : IO Config Menu (1)

- Line 1 – defines input type and terminal number, above display shows Universal Input #1
- Line 2 – is a menu command and allows the user to return to the previous page
- Line 3 – defines the input type, in this case a measured value, Temperature
- Line 4 – defines whether the output has been *forced* (ie. manually overridden).









Using the  or  buttons, select the IO type. Paging to the right will display the Digital Inputs, then the Analogue Outputs. Select the correct type and use the  or  buttons to select the specific port required. A typical screen display is shown right.



Figure 79 : IO Config Menu (2)

To *force* or manually override an input or output, press  and the displayed *FORCED* command will flash.

Press the  button, to change the display to Yes and the *FORCED* Value will then appear. Press  button to select this and the Forced Value will flash and using the  or  buttons, the override can be set to the value required.

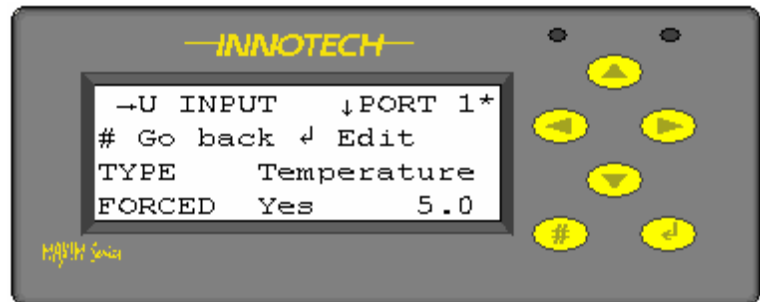

Figure 80 : IO Config Menu (3)

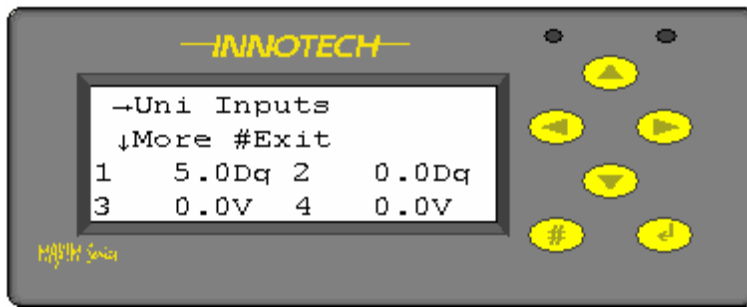

Figure 81 : IO Values Display

When finished, press to save or to abort the new setting.

When an input or output has been overridden, the Watch will display the forced value, but it will not show that it has been overridden. To see if any values have been manually forced, check the *IO Values* displays.

Where a manual override has been applied, the respective input or output will flash.

3-3-3 Setup – PID PAR

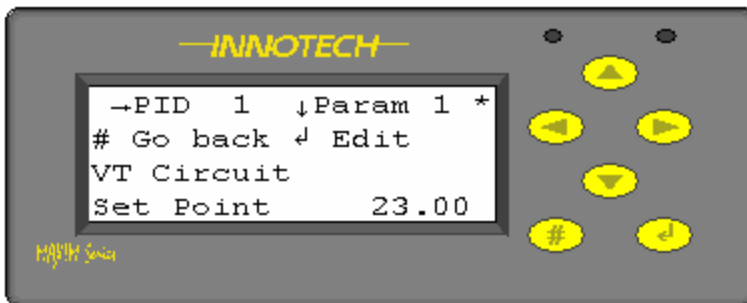

Figure 82 : PID PAR

This series of screen displays shows the user the internal block values for any PID control loops used within the software configuration of the controller. These can now be adjusted as required without having to connect a personal computer.

The PID Loop block is a twin output proportional plus integral and derivative control loop.

It is one of the primary control blocks used for maintaining constant temperature, humidity or controlled variable.

Line 1 – defines the PID block number, in the above case we are looking at PID Loop #1.

Line 2 – is a menu command and allows the user to return to the previous page or to edit the parameter currently being displayed.

Line 3 – defines the block name, in this case *VT Circuit*.







Line 4 – defines the internal setpoint, *23.00*. Press and change the parameter as required using the , buttons, and then press, to save the new value or to cancel.

Use the , buttons to display the other internal block values and settings, these are listed below:-

- *Setpoint* – This is the setpoint of the PID Loop to which the input to the block should finally settle, which is used only if the **SETPOINT** input to the block is not connected to a **User Variable**. This does not have to be connected, but doing so allows the setpoint to be modified (via an Editable Watch on a User Variable) during Maxim operation.
- *Dead Band* – This is the total range of the Dead Band for the PID Loop. This is the range of values (centred about the Setpoint) in which no Direct or Reverse acting control is used.

- *Alpha* – This is a smoothing constant (percentage) used in the integral and derivative calculations for the block. It is a representation of how fast the output value will change to meet the required value. An alpha of 100% will change immediately to the required value, whereas an alpha of 50% will only move half way toward the required value each time the block is processed. Note: If Alpha is set to 0% the block behaves the same as if it was set to 100% (otherwise the block output value would never change).
- *Direct P* (also *Direct I* and *Direct D*) – This group of fields provides for the setting of the Proportional Band range for the PID control loop as well as fine tuning of the derivative and integral constants for the calculation for the direct acting part of the PID Loop.
- *Reverse P* (also *Reverse I* and *Reverse D*) – This group of fields provides for the setting of the Proportional Band range for the PID control loop as well as fine tuning of the derivative and integral constants for the calculation for the reverse acting part of the PID Loop.

3-4 Commission

From the Home Page press the  button to display the "Navigate" screen. Use the , , ,  buttons to select the *Commission* function and then press  again.

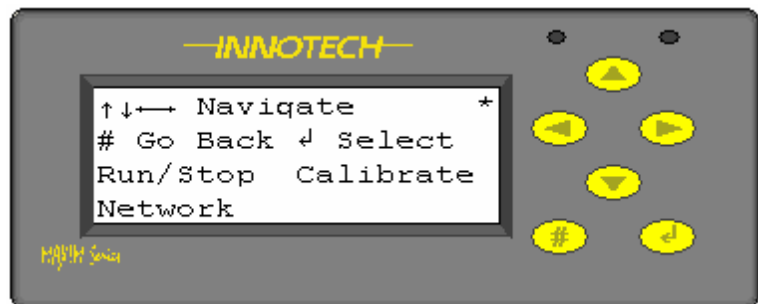

Figure 83 : Commission Display

3-4-1 Commission – Run/Stop

The *Run/Stop* function allows the controller processor to be stopped and started as required. When in the *Stopped* mode processing is suspended and the controller is effectively switched off (ie. analogue outputs would be *OV*, digital outputs would be *Off*).





Figure 84 : Run/Stop Display (1)

This function is extremely useful. It allows a controller to be pre-programmed prior to despatch but putting it into the *Stopped* mode allows it to be powered on site in a safe state. Once all the commissioning checks have been carried out and the user is satisfied all external devices have been correctly connected and configured, changing the state to *Running* then allows the application program to run.





Figure 85 : Run/Stop Display (2)

Line 1 – is a menu command and allows the user to return to the previous page  or  to *Stop* the processor.

Line 3 – is just a text display.

Line 4 – displays the current status of the processor and can be *Running* or *Stopped*.

Press  to toggle the processor between the states. When the required state has been selected, press  to return to the previous page.

3-4-2 Commission – Calibrate

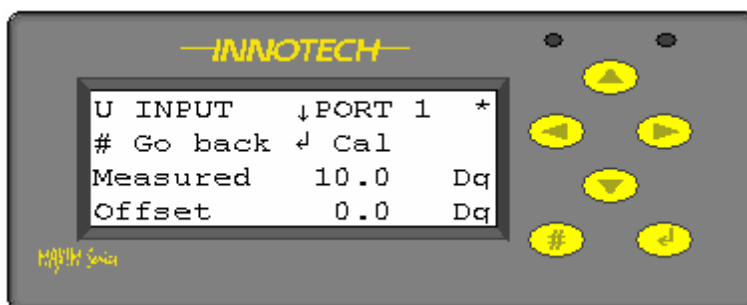

The *Calibrate* function allows the user to view the analogue inputs and see if the signal has been adjusted to take into account any variance in cable resistance or sensor calibration.





Press the ,  buttons to page through the inputs.

Figure 86 : Calibrate (1)

Line 1 – is a text value and shows the Input type, Universal Port no "1". There can be 6 analogue inputs on a Maxim I or II and up to 20 on a Maxim III.

Line 2 – Menu command. Allows user to return to previous page  or  *Calibrate* the input.

Line 3 – displays the *measured value* + the *Offset*

Line 4 – displays current *Offset* value. This is input by the Commissioning Engineer and is the actual measured temperature at the sensor *minus* the value being displayed at the controller.

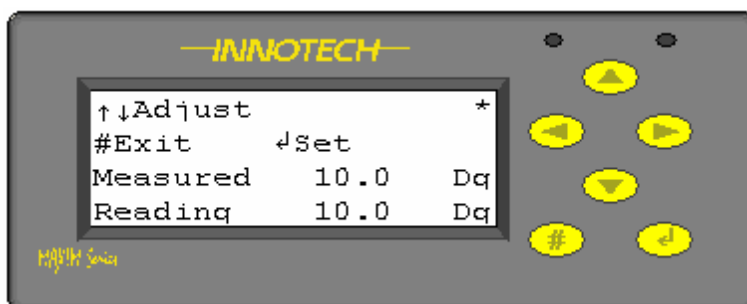

In the example shown, the controller is displaying a measured value of 10.0DegC. If say, the temperature was actually 11.0DegC as measured using a digital thermometer, a 1.0DegC *offset* can be entered to correct the displayed value. This can be + or -. Press  to enter the Calibration mode, above left.

Figure 87 : Calibrate (2)





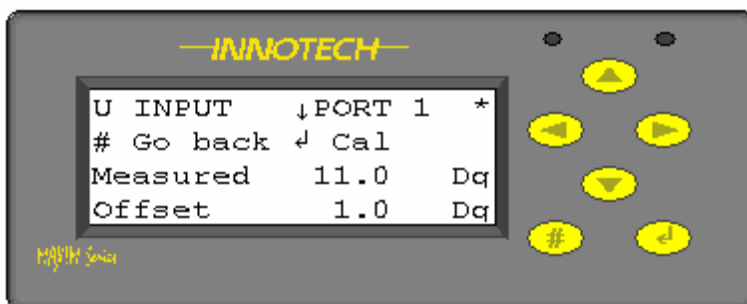

The Measured value is flashing at this point. Use the ,  buttons to change it to the actual measured temperature. Press  to save the revised value or  to exit to the previous screen. The controller will automatically calculate the sensor offset required and this is then displayed on Line 4.

Figure 88 : Calibrate (3)

Press **#** to return to the previous page and the display shows the adjusted values. The Measured value is shown in the respective watches.

Press **#** again to return to the *Commission* display.

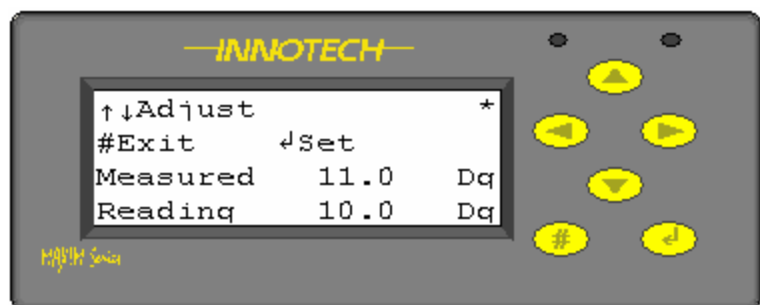

Figure 89 : Calibrate (4)

3-4-3 Commission – Network

From the *Commission* page select *Network* and press the **↵** button to display the screen below. The information displayed is read only.

3-4-3-1 Commission – Network – Status

From the *Network* display menu select *Status* and press **↵**. It is possible to test the controller network using the test function in the software packages (*Communicate – Comms Test*). The PC sends out messages to the device and part of the contents of the message tells it how many messages have been sent.

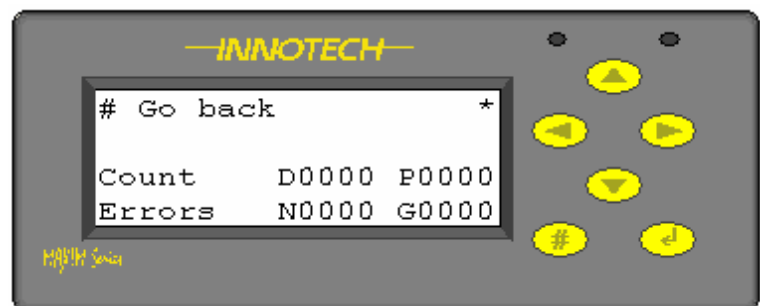

Figure 90 : Network Status

The "D0000" is the number of these network test messages the device has received, and the "P0000" is the number of messages that the PC says have been sent.

If a *Comms Test* is carried out and these numbers aren't the same (or very close) then some messages have gone astray, possibly because of a bad network. In all cases it is advisable to leave the test running for several minutes so as to obtain a significant sample.

The "G0000" and "N0000" are network errors for the Global and Net Comms networks respectively. These are not related to the *Comms Test* described above (although a failure on the there would also show up in the network errors list).

These are "receive" errors only since the device does not check its own transmissions. The device determines that a network message has failed by looking at the header and the message checksums, however if the message is so badly corrupted that it does not begin correctly, it will not appear as a bad message, rather the device will just ignore it until it sees the start of a proper message.

3-4-3-2 Commission – Network – Baud Rate

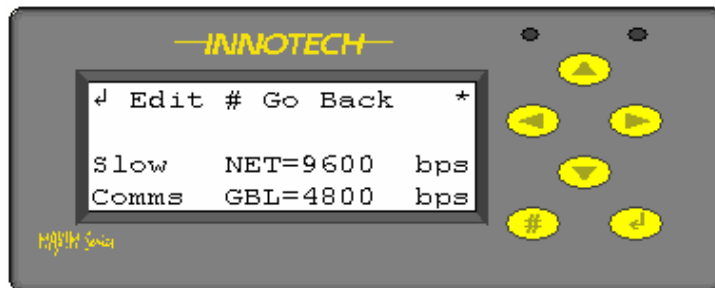

Figure 91 : Network Rate (1)

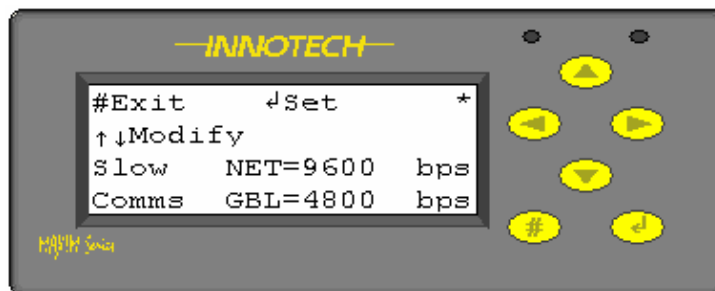

Figure 92 : Network Rate (2)

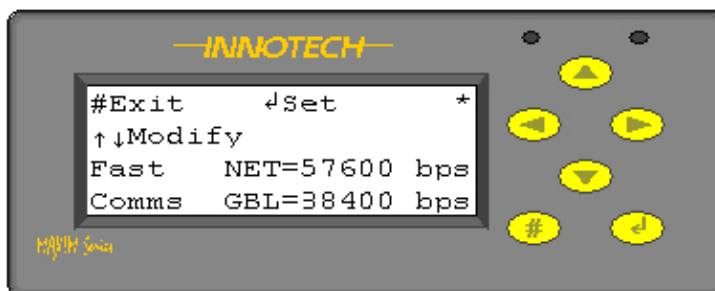







Figure 93 : Network Rate (3)

From the *Network* display menu select *Baud* and press 

This screen displays the speed at which the two networks, Global and Net will communicate with other controllers

Note: V5.1 firmware or below only allows the network to run at the lower Baud rates

To change the selected speed, press , the Slow Comms or Fast Comms will start to flash. Press the ,  buttons and select the required speed and then press  to save the new value or  to exit to the previous screen.

Firmware v6.0 or above allows higher speeds to be selected. Where controllers with new firmware are fitted to legacy systems, the Slow Comms speeds will need to be selected.

On systems where only the new devices are used the Fast Comms speeds can be used.

Net Comms (*NET*) – provides a means to configure or monitor the Maxim Digital Controller from a PC at a speed of 9600 or 57600 baud.

A local PC can be connected to the Net Comms via an MPI or via a GENII Converter USB (USB/RS485 converter) or for legacy systems a GENII Converter NT (RS232/RS485 Converter) can be used.

A PC with a modem at a remote location can access this network through the telephone system via a modem connected to an MPI or GENII Converter NT on the Net Comms. Caution must be exercised if a PC and an MPI or more than one PC is directly connected to the Net Comms. Only one can be active at any time otherwise a conflict between them causes data corruption.

Global Comms (*GBL*) - provides a means for control data to be shared between the Digital Controllers and a GENII MPI at a data speed of 4800 or 38400 baud. There is no facility to connect a PC to the Global Points network through a Digital Controller or GENII MPI. If it is necessary to monitor the Global Points traffic, a GENII CONVERTER can be used to connect to the Global Points Comms cable and use the Genesis Global Points Monitor software to view the data.

MAXIM II

Overview

The *MAXIM II* Controller is a state of the art digital processing system that has the capability of controlling various types of industrial, commercial and domestic systems. The *MAXIM II* can operate as a standalone device, using its own universal inputs and analogue and digital outputs to receive information and control external equipment, or as part of a network of devices that support Global NetComms.

The *MAXIM II's* configuration program is developed on a computer using a Windows based program. This allows the user to configure the internal processes of the *MAXIM II* by using a graphical programming tool. The user places various process blocks and interconnecting lines to design the required control algorithm for the system.

A connector on the bottom right side of the case provides an RS485 serial link to the computer via a 485/232 converter for downloading the configuration program. This link may also be used to upload logged data or the program back out of the controller for modification or debugging purposes.

Features

- 100 millisecond cycle/scan time
- 6 configurable universal inputs
- 6 digital relay outputs
- 4 analogue outputs
- User interface on a 4 line, 20 character LCD Display
- 25 user defined watches
- Data logging of 512 k bytes, approx. 50 000 readings
- Status of I/O points displayed LCD
- 1 RS485 serial communications port for Net Comms
- 1 RS485 serial communications port for Global Comms
- User Selectable Baud Rates:
 - (a) Net 9600 Globals 4800 OR
 - (b) Net 57600 Globals 38400
- All wire connections by 2.5mm screw terminals
- Program resides in non-volatile Flash Ram
- Real Time Clock, battery backed for approximately 5 years

Approvals

The *MAXIM II* Controller conforms to:

- EN 55011 Class B Group 1 & EN 50082-1 for CE Marking
- AS/NZS 2064:1997 for C-Tick Labelling.
- Title 47 CFR, Part 15 Class A for FCC Marking
- UL listed to UL916, File Number E242628

MAXIM II Controller

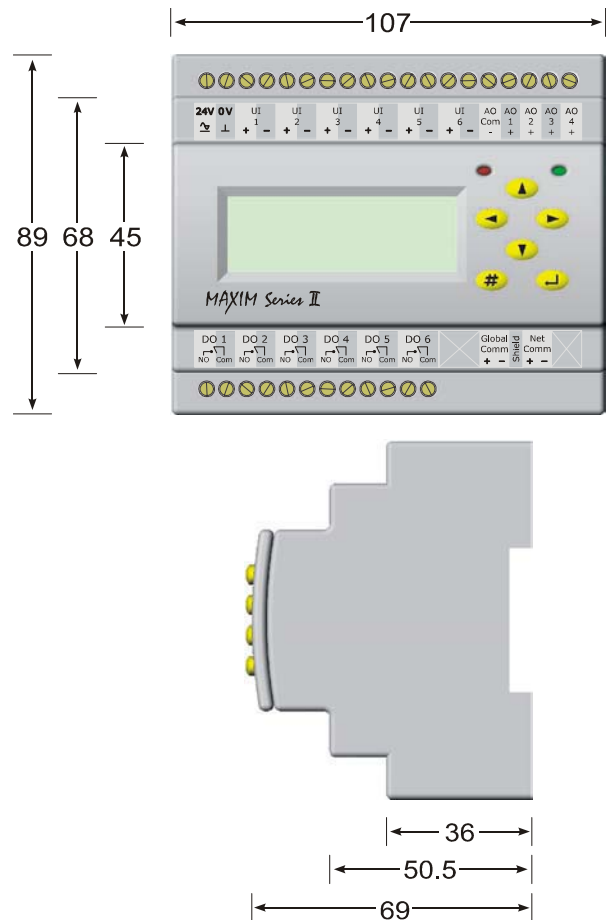

Applications

MAXIM II Controllers are designed for mounting inside a control cubicle and offers a variety of inputs and outputs enabling it to monitor and control all types of external plant and equipment. Although the *MAXIM II* is flexible, it is primarily designed for the air conditioning and building automation industry.

The small size of the *MAXIM II* also gives it the advantage of being fitted in small places without taking up valuable switch-board real-estate.

The *MAXIM II* provides all the features of a stand-alone MAXIM but with many additional features.

The creation of control strategies is made simple by the use of the MAXIM Config configuration utility. This utility with its powerful Graphical User Interface allows the user to create an entire control strategy in block-diagram form.

Typical applications include:

- Air conditioning and heating systems
- Lighting control
- Time clock controller
- Monitoring device
- Distributed I/O points controller
- Cold/Freezer Rooms

Specifications

Power Supply

- 24VAC ± 10% @ 50/60 Hz.
- 24VDC ± 10%.

Transformer nominal rating of 5VA.

The operating voltage must meet the requirements of Safety Extra Low Voltage (SELV) to EN60730. The transformer used must be a **Class 2 safety transformer** that has the energy and voltage limiting characteristics as described in the National Electrical Code, ANSI/NFPA70. It must also be sized and fused in compliance with local safety regulations.

Temperature Ratings

- Storage 0 to 50°C non-condensing.
- Operating 0 to 40°C non-condensing.

Inputs

- 6 Universal Inputs
 Configurable via software to either:
 Dry Digital Inputs
 Voltage Digital Inputs
 10K Thermistor Inputs
 0-10VDC
 LUX sensor input (Light sensor OR P12 LDR)
 Dry Duty Cycle Inputs
 Voltage Duty Cycle Inputs
 Dry Pulse Counter Inputs
 Voltage Pulse Counter Inputs
 Exact Input combinations may be limited by the device.
- Input accuracy is ±0.1 volts.

Input Type	Input Range	Output Range
0-10 Volts DC	0 to 10 V DC	0 to 10 V DC
Dry Digital	Open or Closed	OFF or ON
Voltage Digital	0 to 10 V DC	OFF or ON
High Thermistor	100k to 680 ohms	-20°C to 100°C
LUX Sensor	1Meg ohm to 200 ohms	3 to 2500 LUX
Low Thermistor	662k to 12k ohms	-50°C to 20°C
Dry Duty Cycle	Open or Closed 1 to 13Hz	0 to 100% ±10% accuracy
Voltage Duty Cycle	0-10V Square Wave 1 to 13Hz	0 to 100% ±10% accuracy
Dry Pulse Counter	Open or Closed 20ms Min. ON Time 20ms Min. OFF Time	0 to 25 pulse per second ±1 pulse accuracy *
Voltage Pulse Counter	0-10V Square Wave 20ms Min. ON Time 20ms Min. OFF Time	0 to 25 pulse per second ±1 pulse accuracy *

* Error is less than 0.2% with 15Hz square wave input.

Outputs

- 6 Digital Outputs
 6 x normally open relays (2 amp @ 24VAC)
 Recommended use of pilot relays when switching high voltage/inductive loads
- 4 Analogue Outputs
 1&2 can be configured individually as either linear 0-10VDC or PWM outputs
 3&4 are dedicated linear 0-10VDC outputs
 Output Load >2kOhms
- Note that up to 3 solid state relays can be connected in series, to the analogue outputs when configured as PWM.

Battery

Contains a Lithium Battery, dispose of properly.
 Type CR-2032 Lithium
 Nominal voltage 3 Volts
 Shelf life - 5 Years dependant on ambient temperature
CAUTION: Risk of explosion if battery is replaced by an incorrect type.

Enclosure

The *MAXIM II* is housed in a rectangular case made from flame retardant polycarbonate/ABS plastic listed under UL94.

Colour: Grey
 DIN Rail mounted.

Data Logging

The *MAXIM II* Controller comes with a powerful Data Logging facility. Data Logging can be assigned to hardware and software points. Approximately 50 000 time stamped readings can be stored on the *MAXIM II*. All data is stored in a 512K byte non volatile flash ram. When the memory becomes full, new readings replace the oldest readings. All logged data points can be extracted by using the MAXtract Software tool.

Communications

- RS485:
 5way plug in connector for local/remote computer access for purposes of uploading, downloading and monitoring configuration programs and the extraction of logged data, via a 485/232 converter.

MAXIM Model Number Designations:

	Series	Logging Memory	Display
MAX	2	L	N
MAX	2	L	D

User Interface

For ease of use the *MAXIM II* Controller is provided with a 4 line, 20 character Liquid Crystal Display and Keypad. Keypad consists of six navigational push buttons to provide input into the system. These buttons are “Up”, “Down”, “Left”, “Right”, “Enter”, “Escape”. Using these buttons, the user can gain access to the menu structure as shown below.

```
Default —— Status —— Clock —— Setup —— Commission
    ▶ Watches ▶ Set Clock ▶ Var Setup ▶ Run/Stop
    ▶ Alarms ▶ DL Saving ▶ IO Config ▶ Calibrate
    ▶ Sys Info ▶ Schedules ▶ PID Par ▶ Network
    ▶ IO Values
```

The Display has up to 5 programmable watch pages with user defined watch page description, each page displaying 5 points of information, and allows access to the status of all IO values and system information. The user can set clock/schedules variables and calibrate inputs. All information displayed on the display is in English and standard engineering units.

Associated Software

MAXCon - *MAXIM II* Controller Configuration utility. It allows the user to internally configure a *MAXIM II* by a simple point-and-click approach on a PC running Windows.

MAXMon - The MAXIM Monitor is a monitoring and debugging utility designed to help with commissioning and trouble-shooting a *MAXIM II* Controller. It displays the configuration which resides on a *MAXIM II* Controller and allows the user to inspect, trend or modify the value at any of the points in the configuration while the controller is running.

MAXSim - The MAXIM Simulator utility is a Windows-based software program that simulates a *MAXIM II* Controller. The virtual MAXIM II can be powered on, configured and interrogated in the same way as a physical *MAXIM II*. Configurations can be downloaded and checked without requiring any hardware installation.

iComm is a communications server used by application software to communicate with Innotech digital controllers. It supports multiple concurrent applications communicating to multiple device networks and serves as the communications hub of any HMI-integrated device network.

MAXtract - is the data log extraction utility for a range of Innotech digital controllers. It allows extraction of all or part of the history log data residing on the *MAXIM II* into a specified data format.

InnoGraph - is data log graphing and analysis tool. While it has been designed to specifically cater for the data log graphing capabilities of the Innotech range, it has the flexibility to display data log graphing information from other sources. **InnoGraph** allows multiple graphs to be displayed in multiple windows simultaneously. Complete with a host of configurable display options, statistical analysis of data points, analogue and digital value support, active cursors, colour printing capability and comprehensive zooming and panning features, **InnoGraph** is your complete graphing package.

Supervisor is a specialised dynamic monitoring utility for the Genesis II and Maxim Series Digital Controllers. It provides all the functionality that is available from the Genesis II and Maxim Series Digital Controller display panels with greater ease-of-use and flexibility. It is aimed at those users who require some feedback or control of the Genesis II and Maxim system, but have no desire to be immersed in the technical details of a Genesis II and Maxim configurations.

Magellan is an event-driven, object oriented real-time Supervisory Control and Data Acquisition package. It provides a simple, intuitive mechanism to effortlessly design either trivial or sophisticated supervisory or control programs using a drag-and-drop approach.

FCC Class A Notice

This device complies with Part 15 of the FCC Rules. Operation is subject to the following two conditions:

1. This device may not cause harmful interference.
2. This device must accept any interference received, including interference that may cause undesired operation.

Note – This equipment has been tested and found to comply with the limits for a Class A digital device, pursuant to Part 15 of the FCC Rules. These limits are designed to provide reasonable protection against harmful interference when the equipment is operated in a commercial environment. This equipment generates, uses and can radiate radio frequency energy and, if not installed and used in accordance with the instruction manual, may cause harmful interference to radio communications.

Operation of this equipment in a residential area is likely to cause harmful interference in which case the user will be required to correct the interference at his own expense.

Modifications to this device, may void the authority granted to the user by the FCC to operate this equipment.

Maxim II Controller

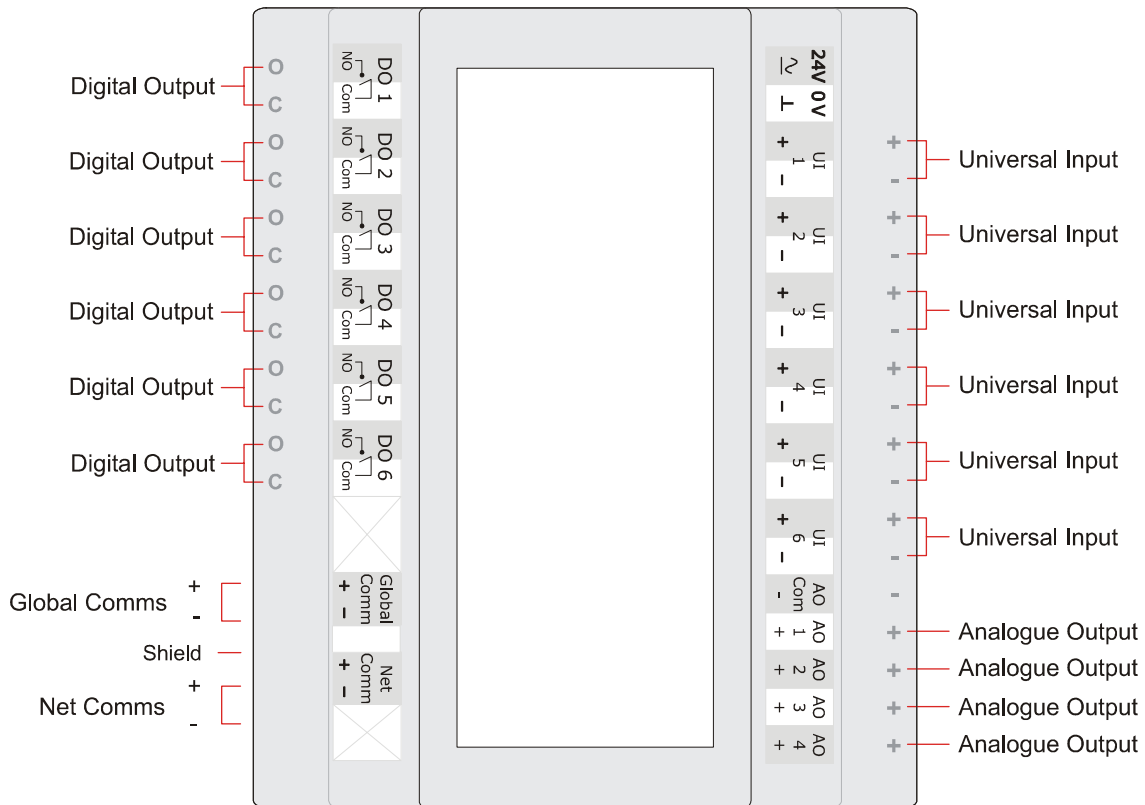

MAXIM III

MAXIM III Controller

Overview

The *MAXIM III* Controller is a state of the art digital processing system that has the capability of controlling various types of industrial, commercial and domestic systems. The *MAXIM III* can operate as a standalone device, using its own universal inputs and analogue and digital outputs to receive information and control external equipment, or as part of a network of devices that support Global NetComms.

The *MAXIM III's* configuration program is developed on a computer using a Windows based program. This allows the user to configure the internal processes of the *MAXIM III* by using a graphical programming tool. The user places various process blocks and interconnecting lines to design the required control algorithm for the system.

The configuration program can be downloaded to the Maxim *III* with an RS485 serial link, using the connector on the right side of the case to link to the computer via a 485/232 converter, or with an optional Ethernet link, using the RJ45 connector on the bottom right side of the case. These links may also be used to upload logged data or the program back out of the controller for modification or debugging purposes.

Features

- 500 millisecond cycle/scan time
- 20 configurable universal inputs
- 12 digital relay outputs
- 8 analogue outputs
- Optional user interface on a 4 line, 20 character LCD display
- Optional Ethernet connection for Net Comms
- Status of I/O points displayed on LCD
- 80 user defined watches (up to eight pages of up to 10 watches)
- Data logging of 2MBytes, up to 300,000 readings
- 1 RS485 serial communications port for Net Comms
- 1 RS485 serial communications port for Global Comms
- User Selectable Baud Rates:
 - (a) Net 9600 Global 4800 OR
 - (b) Net 57600 Global 38400
- All wire connections by 2.5mm plug-in screw terminals
- Program resides in non-volatile Flash Ram
- Real Time Clock, battery backed for approximately 5 years



Approvals

The *MAXIM III* Controller conforms to

- EN 61326:1998 for CE Marking and C-Tick Labelling
- Title 47 CFR, Part 15 Class A for FCC Marking
- UL listed to UL916, File Number E242628

Applications

MAXIM III Controllers are designed for mounting inside a control cubicle and offers a variety of inputs and outputs enabling it to monitor and control all types of external plant and equipment. Although the *MAXIM III* is flexible, it is primarily designed for the air conditioning and building automation industry.

The *MAXIM III* provides all the features of MAXIM II with an extended Input/Output count, increased memory resources and optional RJ45 port for Ethernet Communications.

The creation of control strategies is made simple by the use of the MAXIM Config configuration utility. This utility with its powerful Graphical User Interface allows the user to create an entire control strategy in block-diagram form.

Typical applications include:

- Air conditioning and heating systems
- Lighting control
- Time clock controller
- Monitoring device
- Distributed I/O points controller
- Cold/Freezer Rooms

Specifications

Power Supply

- 24VAC \pm 10% @ 50/60 Hz.
- 24VDC \pm 10%.

Transformer nominal rating of 10VA.

The operating voltage must meet the requirements of Safe Extra Low Voltage (SELV) to EN60730. The transformer used must be a Class 2 safety transformer in compliance with EN60742 and be designed for 100% duty. It must also be sized and fused in compliance with local safety regulations.

Battery

Contains a Lithium Battery, dispose of properly

Type CR-2032 Lithium Battery

Nominal voltage 3 Volts

Shelf life - 5 Years dependant on ambient temperature

CAUTION - Risk of explosion if battery is replaced by an incorrect type

Inputs

- 20 Universal Inputs

Configurable via software to either:

Dry Digital Inputs

Voltage Digital Inputs

10K Thermistor Inputs

0-10VDC

LUX sensor input (Light sensor OR P12 LDR)

Dry Duty Cycle Inputs

Voltage Duty Cycle Inputs

Dry Pulse Counter Inputs

Voltage Pulse Counter Inputs

Input combinations may be limited by the device, to be set in pairs.

- Input accuracy is \pm 0.1 volts.

Input Type	Input Range	Output Range
0-10 Volts DC	0 to 10 V DC	0 to 10 V DC
Dry Digital	Open or Closed	OFF or ON
Voltage Digital	0 to 10 V DC	OFF or ON
High Thermistor	100k to 680 ohms	-20°C to 100°C
LUX Sensor	1Meg ohm to 200 ohms	3 to 2500 LUX
Low Thermistor	662k to 12k ohms	-50°C to 20°C
Dry Duty Cycle	Open or Closed 1 to 13Hz	0 to 100% \pm 10% accuracy
Voltage Duty Cycle	0-10V Square Wave 1 to 13Hz	0 to 100% \pm 10% accuracy
Dry Pulse Counter	Open or Closed 20ms Min. ON Time 20ms Min. OFF Time	0 to 25 pulse per second \pm 1 pulse accuracy *
Voltage Pulse Counter	0-10V Square Wave 20ms Min. ON Time 20ms Min. OFF Time	0 to 25 pulse per second \pm 1 pulse accuracy *

* Error is less than 0.2% with 15Hz Square Wave input.

Outputs

- 12 Digital Outputs
12 x normally open relays (2 amp @ 24VAC) supplied by a Class 2 Transformer
Recommended use of pilot relays when switching high voltage/inductive loads
- 8 Analogue Outputs
That can be configured individually as either linear 0-10VDC or PWM outputs
Output Load >2kOhms
- Note that up to 3 solid state relays can be connected in series, to the analogue outputs when configured as PWM.

Temperature Ratings

- Storage 0 to 50°C non-condensing.
- Operating 0 to 40°C non-condensing.

Enclosure

The *MAXIM III* is housed in rectangular case made from flame retardant ABS plastic in accordance with IEC695-2-1 (HD444-2-1) as of EN6335-1, A2 and IEC707 (AS/NZS2420) listed under UL94.

Colour: Grey

DIN Rail mounted.

Data Logging

The *MAXIM III* Controller comes with a powerful Data Logging facility. Data Logging can be assigned to hardware and software points. Up to 300,000 time stamped readings can be stored on the *MAXIM III*. All data is stored in a 2Mbyte non volatile flash ram. When the memory becomes full, new readings replace the oldest readings. All logged data points can be extracted by using the MAXtract Software tool.

Communications

- RS485:
5way plug in connector for local/remote computer access for purposes of uploading, downloading and monitoring configuration programs and the extraction of logged data, via a 485/232 converter.
- Ethernet:
An optional RJ45 Ethernet port for PC and Internet access to the *Maxim III* and other devices connected to it in an Innotech Net Comms network. This has the same functionality as an external RS485 to Ethernet Converter.

MAXIM III Model Number Designations:

	RJ45	Logging	Display
MAX3	E	L	D
MAX3	E	L	N
MAX3	N	L	D
MAX3	N	L	N

User Interface

For ease of use the *MAXIM III* Controller is provided with a 4 line, 20 character Liquid Crystal Display and Keypad. Keypad consists of six navigational push buttons to provide input into the system. These buttons are “Up”, “Down”, “Left”, “Right”, “Enter”, “Escape”. Using these buttons, the user can gain access to the menu structure as shown below.

```
Default  ———  Status  ———  Clock  ———  Setup  ———  Commission
      |
      | ▶ Watches  ▶ Set Clock  ▶ Var Setup  ▶ Run/Stop
      |
      | ▶ Alarms   ▶ DL Saving  ▶ IO Config ▶ Calibrate
      |
      | ▶ Sys Info ▶ Schedules ▶ PID Par   ▶ Network
      |
      | ▶ IO Values
```

The Display has up to 8 programmable watch pages with user defined watch page descriptions, each page displaying 10 points of information, and allows access to the status of all IO values and system information. The user can set clock/schedules variables and calibrate inputs. All information displayed on the display is in English and standard engineering units.

Initial Ethernet Port Setup

The Ethernet Port requires some initial setup according to the network configuration it is being installed onto. *Ethermate* is capable of configuring the Ethernet via several options using the Ethernet RS485 interface. Note that an *CONVERTER-NT* will be required to configure the device if using the RS485 interface and then a PC serial port.

1. The Ethernet Port will require an IP Address. The factory settings will enable the device to acquire an IP Address from a DHCP server. If there is no DHCP server on the network the the device will need a static IP Address assigned. *ETHERMATE* can configure the IP Address using the Ethernet interface or the RS485 interface. See *ETHERMATE* on-line help for more information on IP Address assignment.

2. The Serial Port will need to be configured to match the RS485 network settings. The default is 9600bps, No Parity, 8 data bits and 1 stop bit.

3. The Port number used for the Ethernet connection will need to be configured to match the setting used in *iComm*. The default is 20000.

See *ETHERMATE* on-line help for more information.

Associated Software

MAXCon - MAXIM Controller Configuration utility. It allows the user to internally configure a MAXIM III by a simple point-and-click approach on a PC running Windows.

MAXMon - The MAXIM Monitor is a monitoring and debugging utility designed to help with commissioning and trouble-shooting a MAXIM III Controller. It displays the configuration which resides on a MAXIM III Controller and allows the user to inspect, trend or modify the value at any of the points in the configuration while the controller is running.

MAXSim - The MAXIM Simulator utility is a Windows-based software program that simulates a MAXIM III Controller. The virtual MAXIM III can be powered on, configured and interrogated in the same way as a physical MAXIM III. Configurations can be downloaded and checked without requiring any hardware installation.

iComm is a communications server used by application software to communicate with digital controllers. It supports multiple concurrent applications communicating to multiple device networks and serves as the communications hub of any HMI-integrated device network.

MAXtract - is the data log extraction utility for a range of digital controllers. It allows extraction of all or part of the history log data residing on the MAXIM III into a specified data format.

InnoGraph - is data log graphing and analysis tool. While it has been designed to specifically cater for the data log graphing capabilities of the range, it has the flexibility to display data log graphing information from other sources. **InnoGraph** allows multiple graphs to be displayed in multiple windows simultaneously. Complete with a host of configurable display options, statistical analysis of data points, analogue and digital value support, active cursors, colour printing capability and comprehensive zooming and panning features, **InnoGraph** is your complete graphing package.

Supervisor is a specialised dynamic monitoring utility for the Genesis II and Maxim Series Digital Controllers. It provides all the functionality that is available from the Genesis II and Maxim Series Digital Controller display panels with greater ease-of-use and flexibility. It is aimed at those users who require some feedback or control of the Genesis II and Maxim systems, but have no desire to be immersed in the technical details of a Genesis II and Maxim configurations.

EtherMate is a specialised configuration tool for Ethernet enabled devices. It provides the functionality to set the RS485 baud rate, serial format and TCP/IP settings. Although the device is setup using the Ethernet interface it is possible to configure using the serial port from Terminal function.

Magellan is an event-driven, object oriented real-time Supervisory Control and Data Acquisition package. It provides a simple, intuitive mechanism to effortlessly design either trivial or sophisticated supervisory or control programs using a drag-and-drop approach.

FCC Class A Notice

This device complies with Part 15 of the FCC Rules. Operation is subject to the following two conditions:

1. This device may not cause harmful interference.
2. This device must accept any interference received, including interference that may cause undesired operation.

Note – This equipment has been tested and found to comply with the limits for a Class A digital device, pursuant to Part 15 of the FCC Rules. These limits are designed to provide reasonable protection against harmful interference when the equipment is operated in a commercial environment. This equipment generates, uses and can radiate radio frequency energy and, if not installed and used in accordance with the instruction manual, may cause harmful interference to radio communications.

Operation of this equipment in a residential area is likely to cause harmful interference in which case the user will be required to correct the interference at his own expense.

Modifications to this device, may void the authority granted to the user by the FCC to operate this equipment.

Maxim III: Dimensions

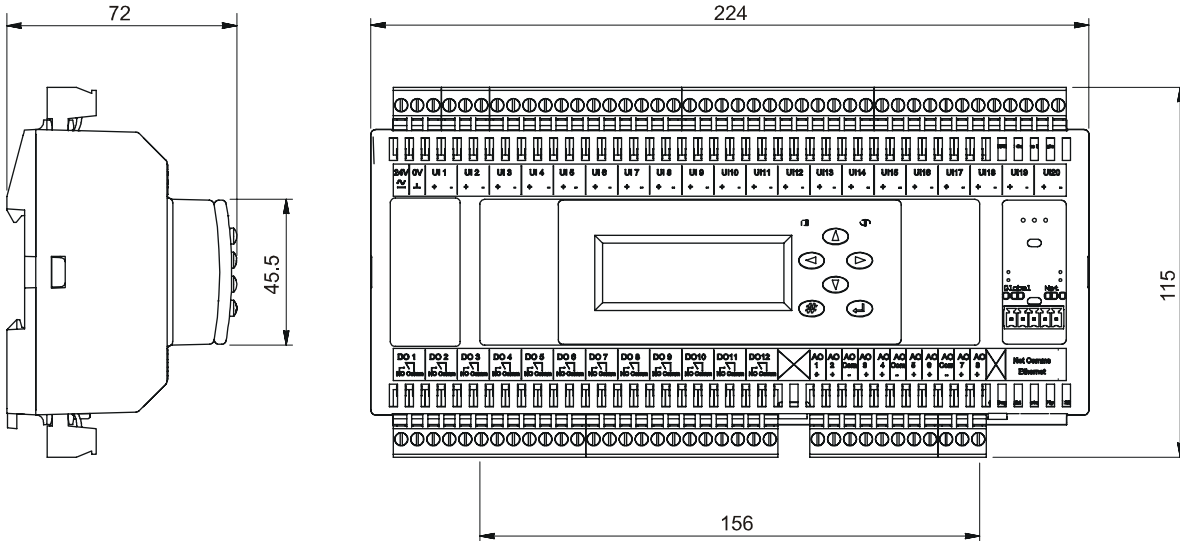

Maxim III: Connection Diagram

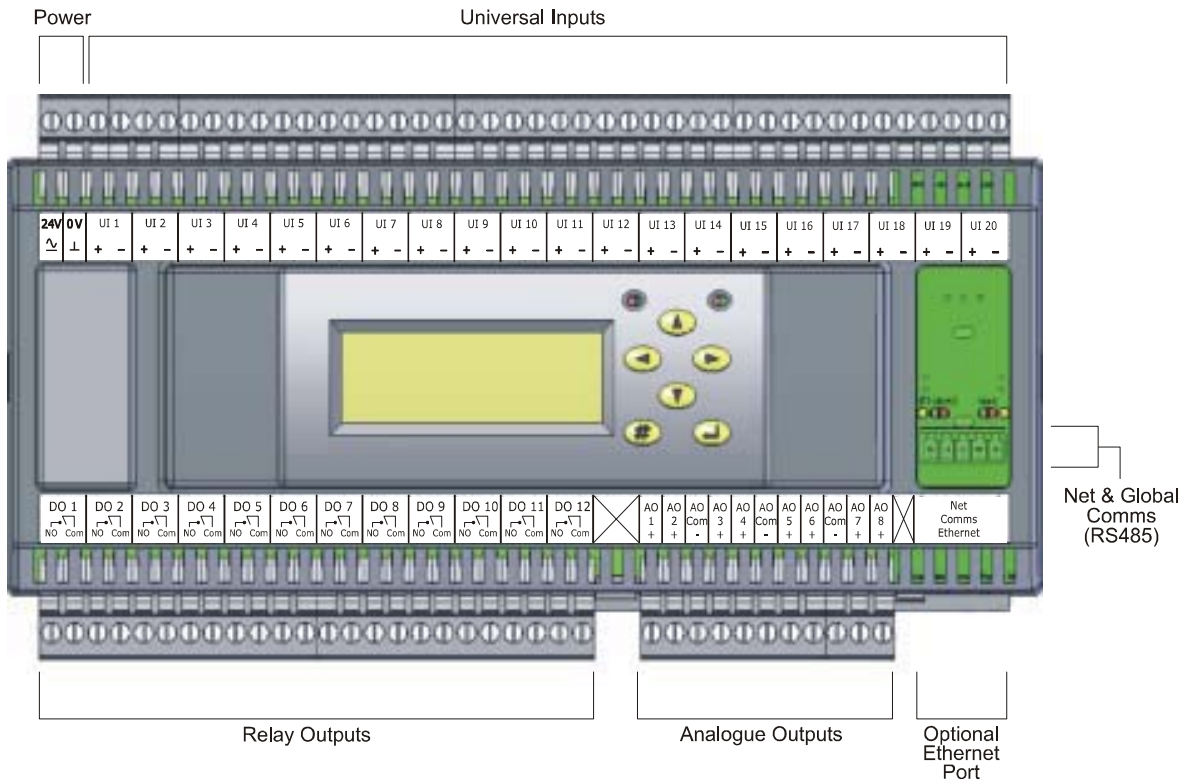

Innotech MAXIM Controller (v6.10)

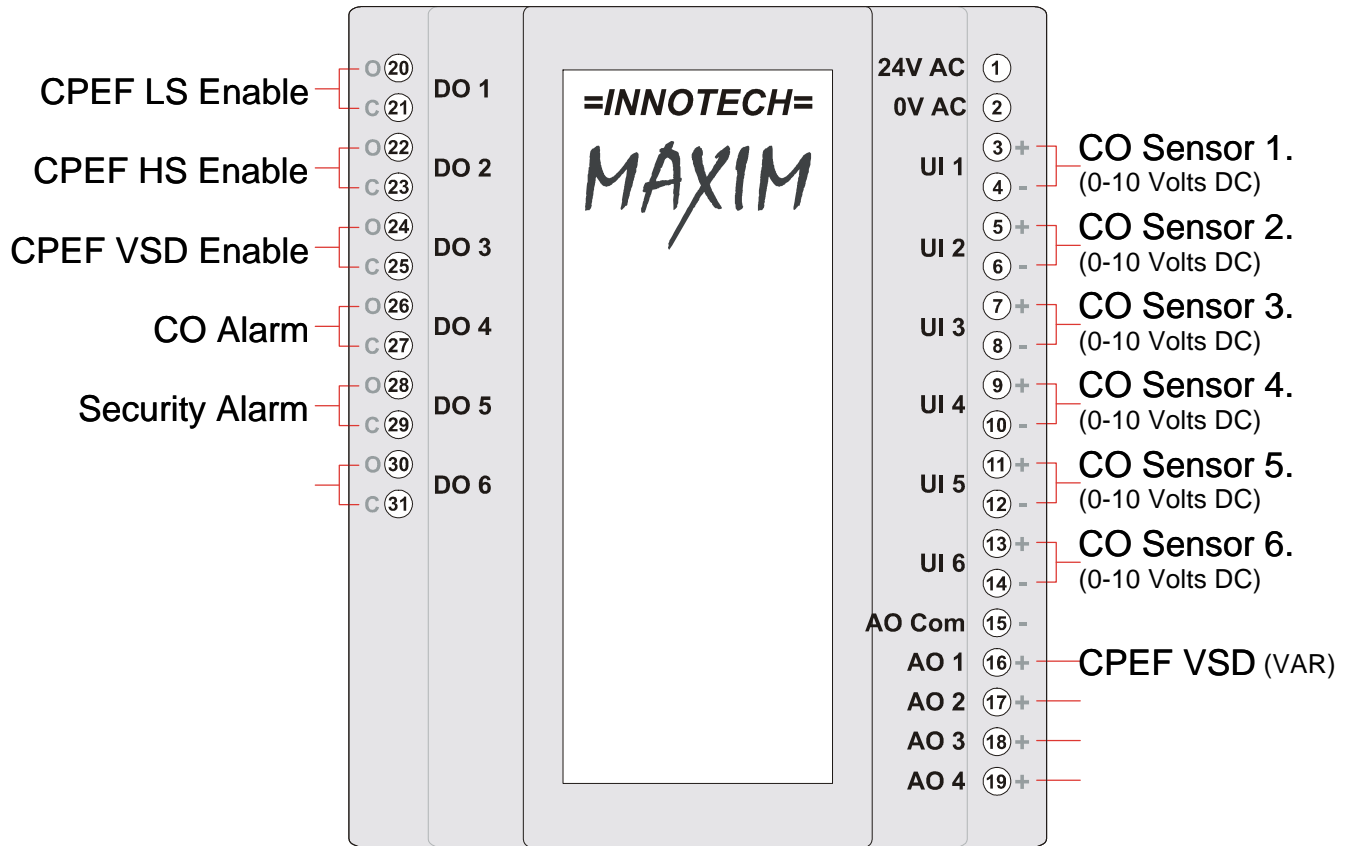

Innotech MAXIM Series III Controller (v6.10)

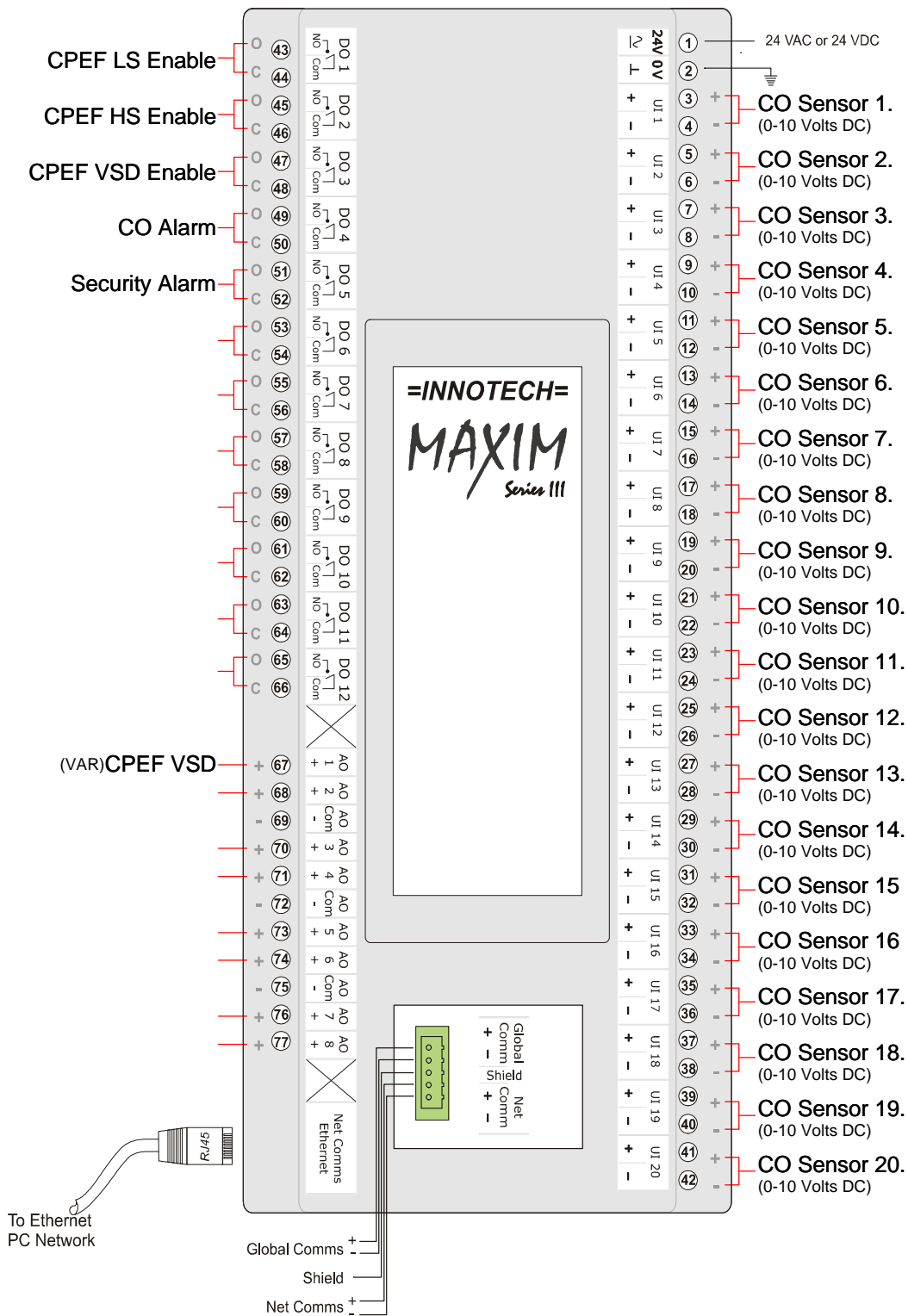

GTA-65 Series

Sensor & 4-20mA Transmitter



GasTech Australia has used the latest electrochemical technology for the detection of a large number of gas in ppm and ppb levels.

The GasTech's unique CO sensor has a built in generator cell which will generate a small amount of interference gas over the sensor giving the user a confidence check that the sensor and system is operating as required.

The Built In Test (BIT) is simply activated by placing a magnet between "GAS TYPE" and "RANGE" on the front cover until the green LED starts to brighten. If the BIT is successful and everything is working correctly the green LED will change to Red for a few seconds then returns to Green for normal operation. This gives the user indication that the BIT was successful. Once the test is complete the green LED will dim and the sensor will return to normal operation within 60 seconds. This feature is only compatible with our CO sensors.

Simple user friendly calibration procedure for routine calibrations

Industry standard 4-20mA output

Housed in a die cast, powder coated, EMI/RFI resistant housing.

Tamper proof construction

GasTech large range of standard sensors

RFI/EMI Resistant powder coated protective case

Gas concentration indicator

MTBF 10 years on electronics

10-30VDC operation

4-20mA source output

In built automatic sensor test with indication and confirmation (BIT)

-20° C to +50° C operating temp



GTA-65 Series

Sensor & 4-20mA Transmitter Specifications

Range of Gases Detected	Ammonia (NH ₃) 0 to 100 ppm	in 1 ppm increments
	Carbon Monoxide (CO) 0 to 100 ppm	in 1 ppm increments
	Chlorine (CL ₂) 0 to 10 ppm	in 0.1 ppm increments
	Hydrogen (H ₂) 0 to 100 ppm	in 0.5 ppm increments
	Hydrogen Cyanide (HCN) 0 to 50 ppm	in 1 ppm increments
	Hydrogen Sulfide (H ₂ S) 0 to 200 ppm	in 1 ppm increments
	Hydrogen Chloride (HCL) 0 to 200 ppm	in 1 ppm increments
	Nitric Oxide (NO) 0 to 100 ppm	in 1 ppm increments
	Nitrogen Dioxide (NO ₂) 0 to 10 ppm	in 0.1 ppm increments
	Phosphine (PH ₃) 0 to 1 ppm	in 0.01 ppm increments
	Sulfur Dioxide (SO ₂) 0 to 10 ppm	in 0.1 ppm increments
	Ethylene Oxide (ETO) 0 to 20 ppm	in 0.1 ppm increments
	Ozone (O ₃) 0 to 2 ppm	in 20 ppb increments
	Oxygen (O ₂) 0 to 25%	in 0.1 %Vol increments

Specifications

Analog Output	4-20mA
Indication	Green LED brightens on increasing gas level
Over range indication	Red LED
Relay Outputs	One user adjustable SPDT (option)
Input Power	10-30VDC (16-30VDC relay unit)
Response Time	90% full scale response in less than 60 seconds
Operating Temperature	-20°C to +50°C
Humidity Range	10-95% non condensing
Accuracy	±5% of reading
Repeatability	±1% of reading
Drift	Less than 5% signal loss per year
Weight	450g
Dimensions	115mm x 90mm x 55mm
Enclosure	IP65
Warranty	2 Years on sensor and electronics

Distributed By

Telephone 1800 999 902
Facsimile 1800 999 903
Int. Phone 61 8 9242 1869
Int. Fax 61 8 9242 1959
Email info@gastech.com.au
106, Westpoint Centre
396 Scarborough Beach Road
Osborne Park WA 6017



GTA-65 Series

**GasTech Australia Pty.
Ltd.**

Instruction Manual

65-1001-CO sensor and amplifier

Manual Version 20112001



Specifications

Detection Method	Electrochemical
Output	4-20mA
Alarm relay (optional)	Two adjustable 24V 3A DC (Order Model 73-1000)
Nominal Range	0-100ppm
Maximum Overload	500ppm
Estimated Operating Life	Greater than Five Years in air
Onboard Filters	To remove H₂S
Temperature Range	-20°C to +50°C
Pressure Range	Atmospheric +/- 10%
T₉₀ Response Time	<60 seconds
Long term output drift	<5% signal loss/year
Repeatability	1% of signal
Output Linearity	Linear
Power Requirements (relay option)	10-30VDC (16 to 30 VDC)
Output Impedance	4 Megohm
Warranty	2 year

Introduction

In many applications it may be more cost effective to replace a sensing head with one pre-calibrated at a testing station or laboratory, so reducing disruption of the measuring system. To enable this, the GasTech Carbon Monoxide Gas Sensor is supplied as a 4-20mA transmitter comprising a five electrode Toxic Gas Sensor and a rectangular printed circuit board (PCB) acting as a temperature compensated Amplifier. The prime features of these units are ease of use, compactness, and the ability to replace both sensor and electronics very quickly.

The PCB has an amplifier circuit to convert the micro amp level output signal of the sensor to the industry standard 4-20mA output for two wire, remote monitoring systems. The circuit employed imposes no constraints on the sensor, so the performance characteristics of the sensor are unaltered by the addition of the circuit board.

Built In Test (BIT) the built in test is unique to our sensor. The sensor has a small gas-generating cell fitted to the back of the sensor. When a magnet is placed on the face of the housing between "Gas Type" and "Range", a reed switch automatically activate the BIT test. This will run for about 10 seconds. A successful BIT activation is indicated by the green LED located to the right of the sensor port will brighten then glow red. The BIT test does not remove the need for gas calibration, this feature is a confidence check so the operator can check to see if the sensor is operating. During the BIT the mA signal should go high for a successful test. A 28-30mA signal is normal for a new sensor.

Every transmitter is supplied pre-calibrated for a customer specified range. The table below gives an indication of the ranges available for each particular sensor. For a full list of ranges please refer back to

GasTech Australia Pty Ltd. Any sensor can be re-calibrated to an intermediate range, using the calibration procedure detailed in the section Calibration.

Except for periodic re-calibration, transmitters are maintenance free, and should give faultless service throughout the working life of the sensor. It is a matter of customer choice whether the unit is replaced automatically at the time of re-calibration or when the sensor fails to calibrate. Operational experience will indicate the most cost effective method of managing the periodic re-calibration requirements.

Power Supply

Transmitters can be operated with any power supply within the range 10 to 30 VDC. However the power supply used will impose constraints on the total loop resistance in the external circuit, and this must be taken into account when selecting the supply voltage. This includes the measuring resistor at the remote receiver and any meters for calibration etc. The following example illustrates the relationship between the two parameters.

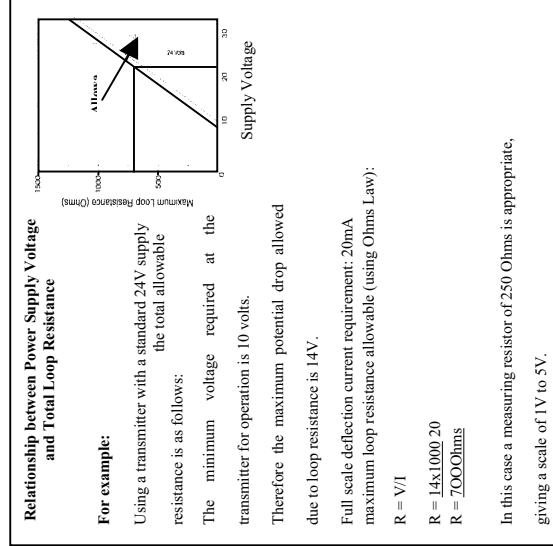

Calibration

GasTech transmitters are supplied pre-calibrated and the sensitivity of the device should not drift more than 1.2% of full signal per month. Potentiometers for routine span and zero adjustment are located on the circuit board.

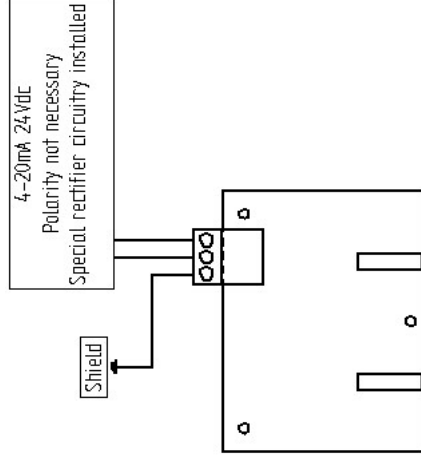

For calibration purposes, the signal may be monitored using either a local meter connected across TP1 and TP2 for mV or TP3 and TP4 for mA, or by a remote receiver. A small non-metallic screwdriver, with a 1.2 x 0.5mm tip, is required to adjust the potentiometers. Although in practise, the calibration procedure will be dictated by the hardware system employed, the following procedure will generally apply:-

1. Gain access to the span and zero calibration potentiometers.
2. Ensure the sensor is free from the gas being measured either by purging with an inert gas.
3. Adjust the zero potentiometer until 0ppm is indicated in the measuring system. At 0ppm the current generated by the transmitter should be 40mV across TP1 and TP2 and 4mA across TP3 and TP4.
4. Apply a test gas of known concentration to the sensor using a suitable flow rate of 0.5-1L per minute. The concentration of gas used for calibration should ideally be between 20 and 50% of range.

5. Wait for a stable reading. A two-minute exposure is normally suitable.
6. Adjust the span potentiometer until the correct reading is shown in the measuring system, or either:

The current (mA) in the system is

$$\{16 \times (\text{gas concentration})\} + 4$$

Range of sensor

Example

1. Calibrating a carbon monoxide transmitter with a **range of 0 – 150ppm** using a calibration gas of 50ppm:

$$(\text{mA}) = \frac{(16 \times 50)}{93\text{mV}} + 4 = 9.3\text{mA} \text{ or } 150$$
2. Calibrating a carbon monoxide transmitter with a **range of 0 – 150ppm** using a calibration gas of 100ppm:

$$(\text{mA}) = \frac{(16 \times 100)}{147\text{mV}} + 4 = 14.7\text{mA} \text{ or } 150$$
3. Calibrating a carbon monoxide transmitter with a **range of 0 – 100ppm** using a calibration gas of 50ppm:

$$(\text{mA}) = \frac{(16 \times 50)}{120\text{mV}} + 4 = 12.0\text{mA} \text{ or } 100$$

Spare parts

65-1001	CO sensor for 65-1001-CO
57-1001A	Amp 65 series CO sensor
81-0001A (CO only)	Magnet for BIT activation
81-9979-01	CO 100ppm in N2 103L disposable cylinder
81-9998	Regulator set flow 0.5Lpm
81-9001A	Calibration adaptor 65 Series CO 65-1001A

GASTECH AUSTRALIA PTY LTD

Standard Warranty

1. Consumers have the benefit of conditions and warranties implied by the Australian Trade Practices Act 1974 (TPA) and similar provisions of State and Territory enactments and nothing in these conditions is intended to exclude, restrict or modify any statutory obligation of GASTECH AUSTRALIA PTY LTD (Company).
- 2.a) This warranty relates only to Equipment manufactured and services supplied by the Company, its related corporations and subsidiaries. Equipment or any part thereof which is returned to the Company, transportation prepaid, within 15 months from the date of dispatch from the Company's premises or 12 months from the date of shipment to the ultimate user (whichever occurs first) and is found by the Company, after examination, to be defective in workmanship or materials, will be either repaired or replaced as determined by the Company.
b) Jurisdiction & arbitration limited to & governed by the applicable laws of Australia.
3. This warranty does not apply to:
 - a) replacement or repairs which are required as a results of improper installation, misuse, maladjustment modification or lack of routine maintenance by others;
 - b) items subject to deterioration or consumption in normal service, that is, those which must be cleaned, repaired or replaced routinely such as (but not limited to) lamps, bulbs and fuses, pump diaphragms and valves, absorbent cartridges, filter elements and batteries; or
 - c) goods, materials or parts supplied or manufactured by unrelated third parties and provided to the Purchaser at the specific request of the Purchaser and such goods, materials or parts will be repaired or replaced only to the extent of the original suppliers warranty.
 - d) service repair work, limited 3 month warranty on parts & labour only.
4. Should the Company be liable for breach of a condition or warranty (other than the pursuant to section 69 of the TPA) implied by Division 2 of Part V of the Act (other than that implied by section 69 of the TPA) the liability of the Company for such breach shall, subject to section 68A(2) of the TPA, be limited to one of the following as determined by the Company.
 - a) the replacement of the Equipment or the supply of equivalent Equipment-,
 - b) the payment of the cost of replacing the Equipment or of acquiring equivalent Equipment.

5. Subject to Clauses 2 and 4 and any legislation to the contrary:
- a) representatives and agreements not expressly contained herein shall not be binding upon the Company as conditions, warranties or representations; all such conditions, warranties, and representations on the part of the Company, whether express or implied, statutory or otherwise, whether collateral or antecedent or otherwise are hereby expressly negated and excluded;
 - b) the Company shall be under no liability to the Purchaser for any loss (including but not limited to loss of profits and consequential loss) or for damage to persons or property or for death or injury caused by any act or omission (including negligent acts or omissions) of the Company or the Company's agents, wherever occurring, arising from the subject matter of this agreement;
 - c) the Purchaser shall indemnify the Company against any claims made against the Company by any third party in respect of any such loss, damage, death or injury as is set out in sub-paragraph b) hereof; the Purchaser further agrees to indemnify the Company against all losses and expenses which the Company may suffer or incur due to the failure of the Purchaser fully to observe its obligations under this contract; and
 - d) no warranty is given and no responsibility is accepted by the Company to ensure the Equipment supplied complies with any statutory requirements relating to the marketing of goods. Compliance with such legislation shall be the sole responsibility of the Purchaser.
 - e) the Company specifically denies any liability for the overall performance of any plant or the results of any process with which the Equipment is integrated.